

# **BEC701 - FIBRE OPTIC COMMUNICATION**

# UNIT-I

## INTRODUCTION TO OPTICAL FIBER

- Evolution of fiber Optic system
- Element of an Optical Fiber Transmission link
- Ray Optics
- Optical Fiber Modes and Configurations
- Mode theory of Circular Wave guides
- Overview of Modes
- Key Modal concepts
- Linearly Polarized Modes
- Single Mode Fibers
- Graded Index fiber structure

## Introduction

- An optical Fiber is a thin, flexible, transparent Fiber that acts as a waveguide, or "light pipe", to transmit light between the two ends of the Fiber.
- Optical fibers are widely used in Fiber-optic communications, which permits transmission over longer distances and at higher bandwidths (data rates) than other forms of communication.
- Fibers are used instead of metal wires because signals travel along them with less loss and are also immune to electromagnetic interference.

## Evolution of fiber Optic system

### **First generation**

- The first generation of light wave systems uses GaAs semiconductor laser and operating region was near  $0.8 \mu\text{m}$ . Other specifications of this generation are as under:
  - i) Bit rate : 45 Mb/s
  - ii) Repeater spacing : 10 km

## **Second generation**

- i) Bit rate: 100 Mb/s to 1.7 Gb/s
- ii) Repeater spacing: 50 km
- iii) Operation wavelength: 1.3  $\mu\text{m}$
- iv) Semiconductor: In GaAsP

## **Third generation**

- i) Bit rate : 10 Gb/s
- ii) Repeater spacing: 100 km
- iii) Operating wavelength: 1.55  $\mu\text{m}$

## Evolution of fiber Optic system

### **Fourth generation**

- Fourth generation uses WDM technique. i) Bit rate: 10 Tb/s
- ii) Repeater spacing: > 10,000 km
- Iii) Operating wavelength: 1.45 to 1.62  $\mu\text{m}$

### **Fifth generation**

- Fifth generation uses Raman amplification technique and optical solitons. i) Bit rate: 40 - 160 Gb/s
- ii) Repeater spacing: 24000 km - 35000 km iii) Operating wavelength: 1.53 to 1.57  $\mu\text{m}$

## Element of an Optical Fiber Transmission link

Basic block diagram of optical fiber communication system consists of following important blocks.

1. Transmitter
2. Information channel
3. Receiver.

# Block diagram of OFC system

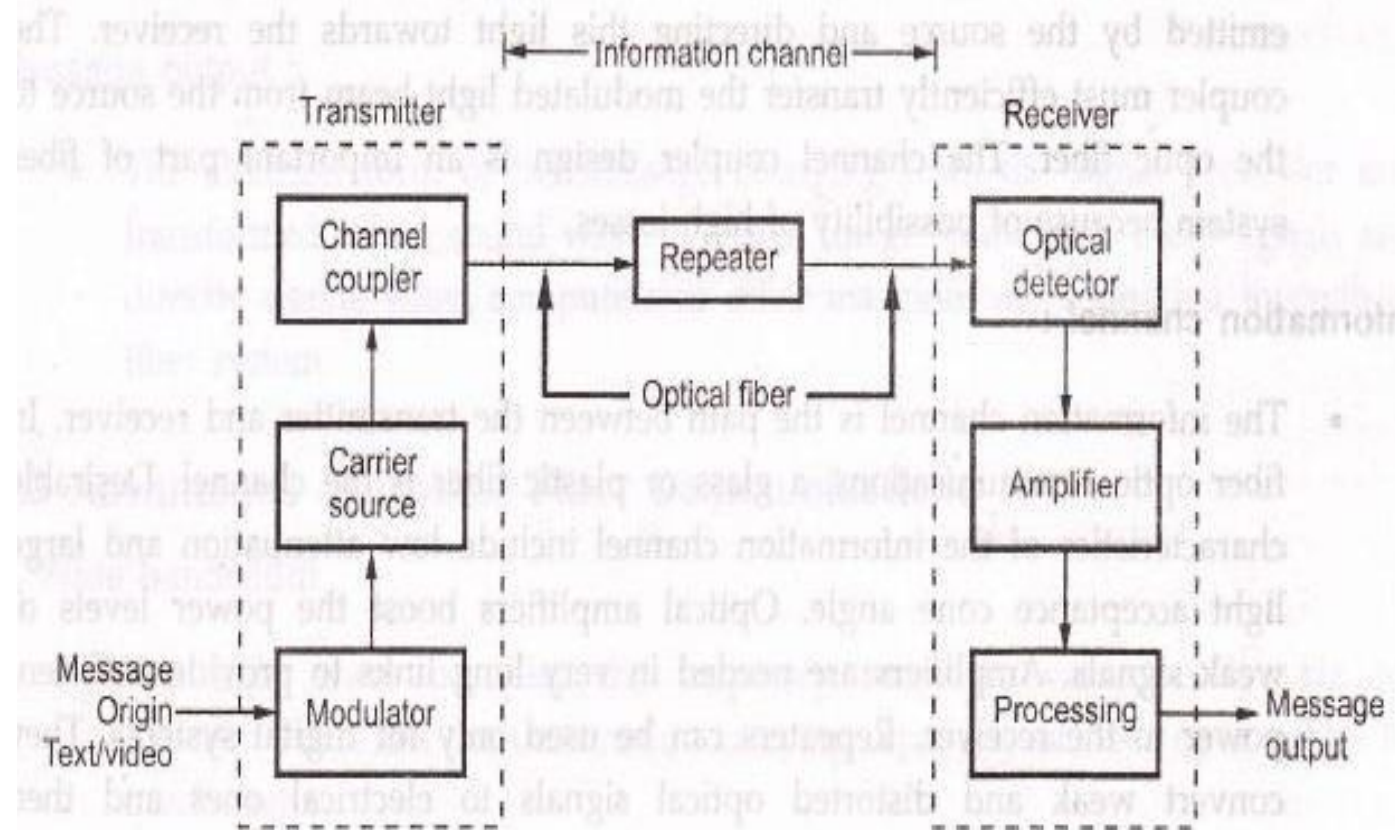

Fig. 1.2.1 Block diagram of OFC systems



- The light beam pulses are then fed into a fiber – optic cable where they are transmitted over long distances.
- At the receiving end, a light sensitive device known as a photocell or light detector is used to detect the light pulses.
- This photocell or photo detector converts the light pulses into an electrical signal.
- The electrical pulses are amplified and reshaped back into digital form.

# Fiber optic Cable

Fiber Optic Cable consists of four parts.

- Core
- Cladding
- Buffer
- Jacket

**Core.** The core of a fiber cable is a cylinder of plastic that runs all along the fiber cable's length, and offers protection by cladding. The diameter of the core depends on the application used. Due to internal reflection, the light travelling within the core reflects from the core, the cladding boundary. The core cross section needs to be a circular one for most of the applications

## **Cladding**

Cladding is an outer optical material that protects the core. The main function of the cladding is that it reflects the light back into the core. When light enters through the core (dense material) into the cladding (less dense material), it changes its angle, and then reflects back to the core.

# Fiber optic Cable

## Buffer

- The main function of the buffer is to protect the fiber from damage and thousands of optical fibers arranged in hundreds of optical cables. These bundles are protected by the cable's outer covering that is called jacket.

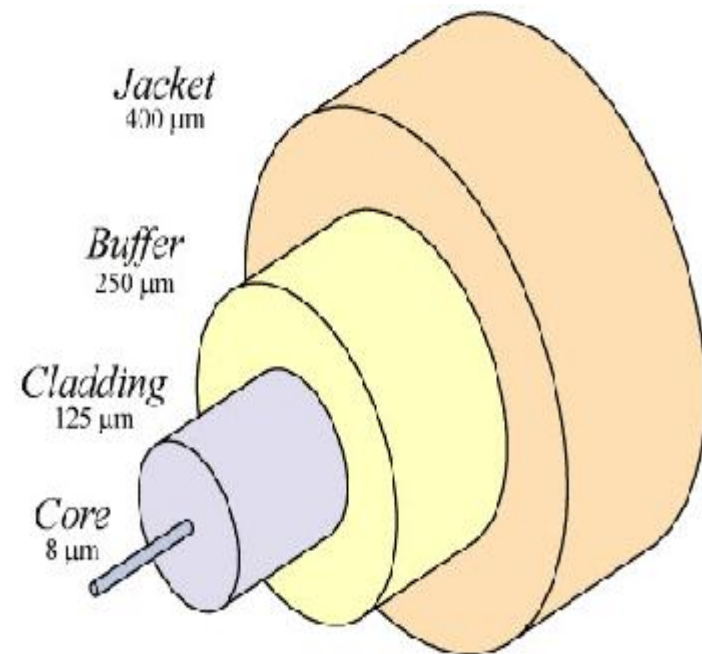

## **JACKET**

Fiber optic cable's jackets are available in different colors that can easily make us recognize the exact color of the cable we are dealing with. The color yellow clearly signifies a single mode cable, and orange color indicates multimode.

- Both the light sources at the sending end and the light detectors on the receiving end must be capable of operating at the same data rate.
- The circuitry that drives the light source and the circuitry that amplifies and processes the detected light must both have suitable high-frequency response.
- The fiber itself must not distort the high-speed light pulses used in the data transmission.
- They are fed to a decoder, such as a Digital – to – Analog converter (D/A), where the original voice or video is recovered.

- In very long transmission systems, repeater units must be used along the way.
- Since the light is greatly attenuated when it travels over long distances, at some point it may be too weak to be received reliably.
- To overcome this problem, special relay stations are used to pick up light beam, convert it back into electrical pulses that are amplified and then retransmit the pulses on another beam.
- Several stages of repeaters may be needed over very long distances.
- But despite the attenuation problem, the loss is less than the loss that occurs with the electric cables.

## Characteristics of fiber

- 1) Wider bandwidth:** The optical carrier frequency is in the range  $10^{13}$  Hz to  $10^{15}$  Hz.
- 2) Low transmission loss:** The fibers having a transmission loss of 0.002 dB/km.
- 3) Dielectric waveguide:** Optical fibers are made from silica which is an electrical insulator. Therefore they do not pickup any electromagnetic wave or any high current lightning.



**4)Signal security:** The transmitted signal through the fibers does not radiate. Further the signal cannot be tapped from a Fiber in an easy manner.

**5)Small size and weight:** Fiber optic cables are developed with small radii, and they are flexible, compact and lightweight. The fiber cables can be bent or twisted without damage.

## Operation of fiber

- A hair-thin Fiber consist of two concentric layers of high-purity silica glass the core and the cladding, which are enclosed by a protective sheath .
- Core and cladding have different refractive indices, with the core having a refractive index,  $n_1$ , which is slightly higher than that of the cladding,  $n_2$ .
- It is this difference in refractive indices that enables the Fiber to guide the light. Because of this guiding property, the Fiber is also referred to as an “optical waveguide.”

## Advantages of optical fiber

**1) WAVELENGTH :**It is a characteristic of light that is emitted from the light source and is measured in nanometres (nm).

**2) FREQUENCY :**It is number of pulse per second emitted from a light source. Frequency is measured in units of hertz (Hz). In terms of optical pulse  $1\text{Hz} = 1$  pulse/ sec.

**3)WINDOWS** :A narrow window is defined as the range of wavelengths at which a fibre best operates.

**4)ATTENUATION:** Attenuation in optical fiber is caused by intrinsic factors, primarily scattering and absorption, and by extrinsic factors, including stress from the manufacturing process, the environment, and physical bending.

**5)DISPERSION** :Dispersion is the spreading of light pulse as its travels down the length of an optical fibre . Dispersion limits the bandwidth or information carrying capacity of a fibre.

## Disadvantages of optical fiber

- High investment cost
- Need for more expensive optical transmitters and receivers
- More difficult and expensive to splice than wires
- Price
- Fragility
- Affected by chemicals
- Opaqueness
- Requires special skills

# Ray Optics

## **Basic laws of ray theory/geometric optics**

- The basic laws of ray theory are quite self-explanatory
- In a homogeneous medium, light rays are straight lines. Light may be absorbed or reflected.
- Reflected ray lies in the plane of incidence and angle of incidence will be equal to the angle of reflection.
- At the boundary between two media of different refractive indices, the refracted ray will lie in the plane of incidence. Snell's Law will give the relationship between the angles of incidence and refraction.

## Ray Optics

### Refraction of light

- As a light ray passes from one transparent medium to another, it changes direction; this phenomenon is called refraction of light. How much that light ray changes its direction depends on the refractive index of the mediums.

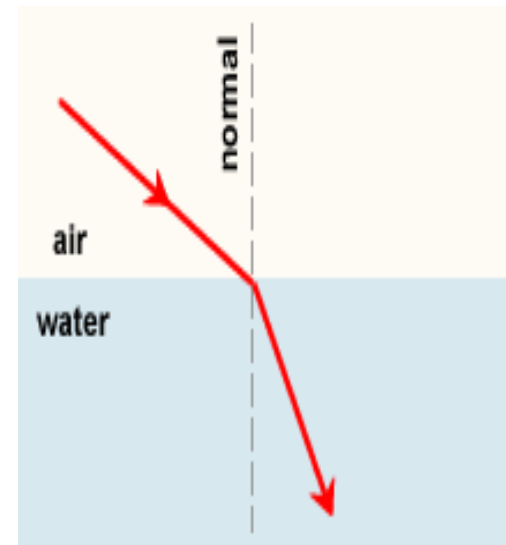

## Ray Optics

### **Refractive Index**

- Refractive index is the speed of light in a vacuum (abbreviated **c**, **c**=299,792.458km/second) divided by the speed of light in a material (abbreviated **v**).  
Refractive index measures how much a material refracts light. Refractive index of a material, abbreviated as **n**, is defined as
- **$n=c/v$**



# Ray Optics

## Snells Law

- When light passes from one transparent material to another, it bends according to Snell's law which is defined as:

$$n_1 \sin(\theta_1) = n_2 \sin(\theta_2)$$

where:

$n_1$  is the refractive index of the medium the light is leaving

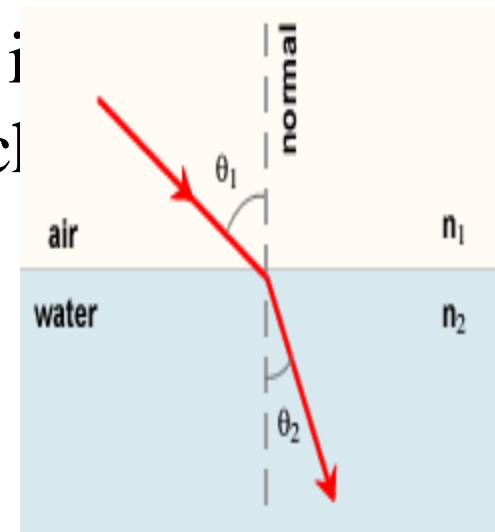

$\theta_1$  is the incident angle between the light beam and the normal (normal is  $90^\circ$  to the interface between two materials)

$n_2$  is the refractive index of the material the light is entering

$\theta_2$  is the refractive angle between the light ray and the normal

## Ray Optics

### Critical angle

- The critical angle can be calculated from Snell's law, putting in an angle of  $90^\circ$  for the angle of the refracted ray  $\theta_2$ . This gives  $\theta_1$ :

Since

$$\theta_2 = 90^\circ$$

So

$$\sin(\theta_2) = 1$$

Then

$$\theta_c = \theta_1 = \arcsin(n_2/n_1)$$

**Numerical Aperture (NA)** For step-index multimode fiber, the acceptance angle is determined only by the indices of refraction:

$$NA = n \sin \theta_{\max} = \sqrt{n_f^2 - n_c^2}$$

Where

$n$  is the refractive index of the medium light is traveling before entering the fiber

$n_f$  is the refractive index of the fiber core

$n_c$  is the refractive index of the cladding

## Ray Optics

### Total internal reflection

- If the light hits the interface at any angle larger than this critical angle, it will not pass through to the second medium at all. Instead, all of it will be reflected back into the first medium, a process known as **total internal reflection**.

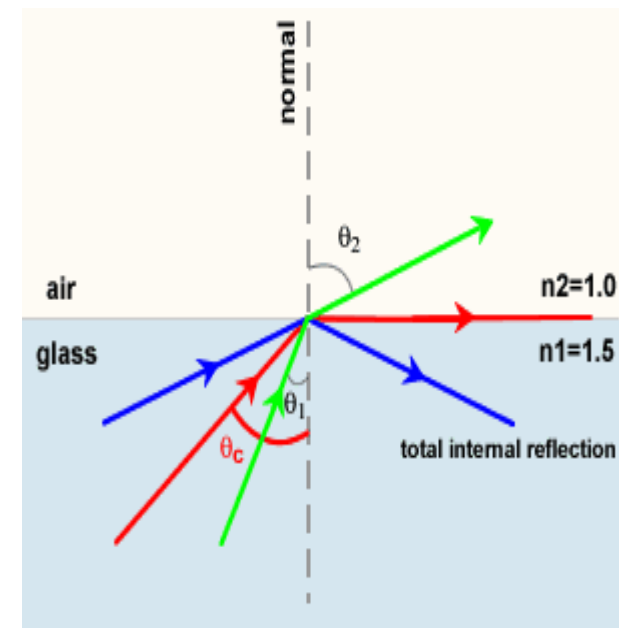

## Fiber Optic Modes

Mode is the one which describes the nature of propagation of electromagnetic waves in a wave guide.

i.e. it is the allowed direction whose associated angles satisfy the conditions for total internal reflection and constructive interference.

Based on the number of modes that propagates through the optical fiber, they are classified as:

- Single mode fibers
- Multi mode fibers

## Single mode fibers

- In a fiber, if only one mode is transmitted through it, then it is said to be a single mode fiber.
- A typical single mode fiber may have a core radius of  $3\ \mu\text{m}$  and a numerical aperture of 0.1 at a wavelength of  $0.8\ \mu\text{m}$ .
- The condition for the single mode operation is given by the  $V$  number of the fiber which is defined as such that  $V \leq 2.405$ .
- Here,  $n_1$  = refractive index of the core;  $a$  = radius of the core;  $\lambda$  = wavelength of the light propagating through the fiber;  $\Delta$  = relative refractive indices difference.

# Single mode fibers

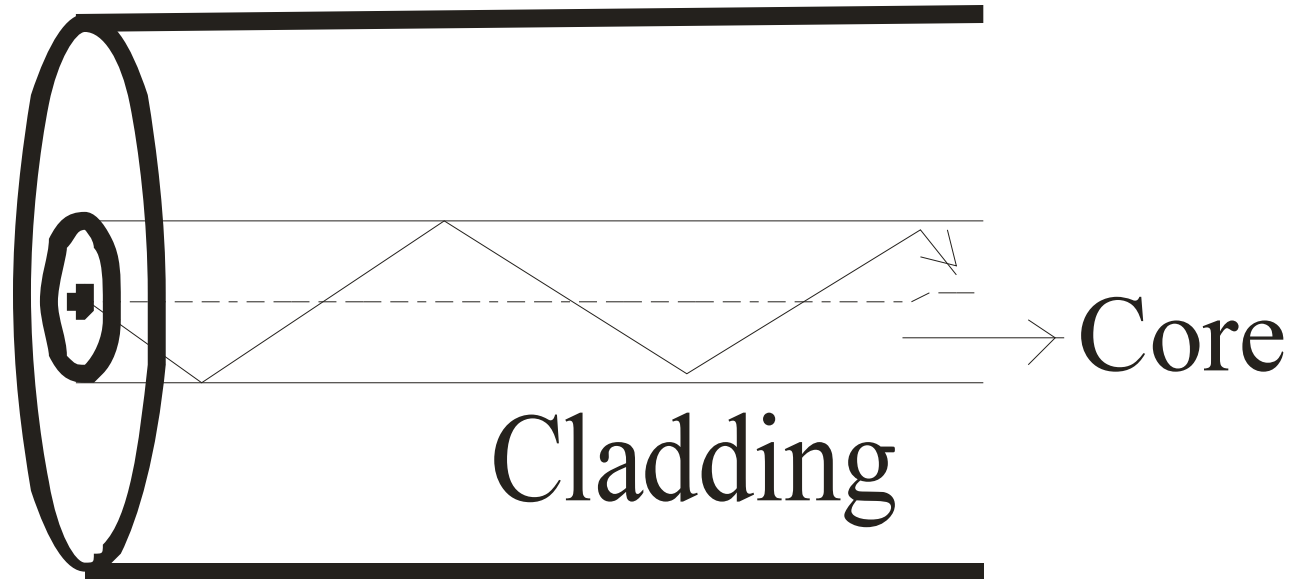



## Single mode fibers

- Only one path is available.
- V-number is less than 2.405
- Core diameter is small
- No dispersion
- Higher band width (1000 MHz)
- Used for long haul communication
- Fabrication is difficult and costly

# Multimode fibers

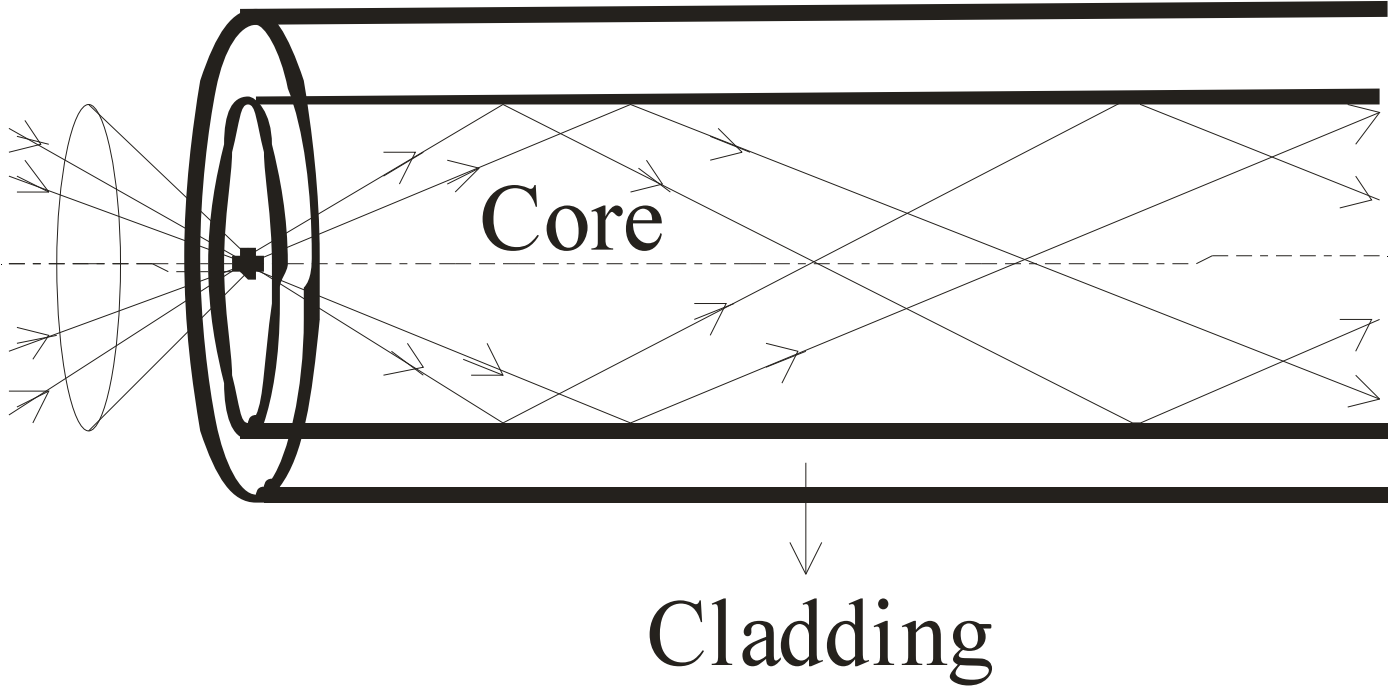

## Multi mode fibers

- If more than one mode is transmitted through optical fiber, then it is said to be a multimode fiber.
- The larger core radii of multimode fibers make it easier to launch optical power into the fiber and facilitate the end to end connection of similar powers.

### **Some of the basic properties of multimode optical fibers are listed below :**

- More than one path is available
- V-number is greater than 2.405

## Types of fibers based on Refractive Index Profile

Based on the refractive index profile of the core and cladding, the optical fibers are classified into two types:

- Step index fiber
- Graded index fiber

## Step index fiber

- In a step index fiber, the refractive index changes in a step fashion, from the centre of the fiber, the core, to the outer shell, the cladding.
- It is high in the core and lower in the cladding. The light in the fiber propagates by bouncing back and forth from core-cladding interface.
- The step index fibers propagate both single and multimode signals within the fiber core.
- The light rays propagating through it are in the form of meridional rays which will cross the fiber core axis during every reflection at the core – cladding boundary and are propagating in a zig – zag manner.

## Step index fiber

- With careful choice of material, dimensions and  $\lambda$ , the total dispersion can be made extremely small, less than  $0.1 \text{ ps / (km} \times \text{nm)}$ , making this fiber suitable for use with high data rates.
- In a single-mode fiber, a part of the light propagates in the cladding.
- The cladding is thick and has low loss.
- Typically, for a core diameter of  $10 \text{ }\mu\text{m}$ , the cladding diameter is about  $120 \text{ }\mu\text{m}$ .
- Handling and manufacturing of single mode step index fiber is more difficult.

## Step index multimode fibers

- A multimode step index fiber is shown.
- In such fibers light propagates in many modes.
- The total number of modes  $M_N$  increases with increase in the numerical aperture.
- For a larger number of modes,  $M_N$  can be approximated by

$$M_N = \frac{V^2}{2} = 4.9 \left[ \frac{d n_1 \sqrt{2\Delta}}{\lambda} \right]^2$$

## Step index multimode fibers

where  $d$  = diameter of the core of the fiber and  $V = V$  – number or normalized frequency.

The normalized frequency  $V$  is a relation among the fiber size, the refractive indices and the wavelength.  $V$  is the normalized frequency or simply the  $V$  number and is given by

$$V = \left( \frac{2\pi a}{\lambda} \right) \times \text{N.A.} = \left( \frac{2\pi a}{\lambda} \right) \times n_1 \times (2\Delta)^{\frac{1}{2}}$$

where  $a$  is the fiber core radius,  $\lambda$  is the operating wavelength,  $n_1$  the core refractive index and  $\Delta$  the relative refractive index difference



## Graded index fiber

- A graded index fiber is shown in Fig.3.27. Here, the refractive index  $n$  in the core varies as we move away from the centre.
- The refractive index of the core is made to vary in the form of parabolic manner such that the maximum refractive index is present at the centre of the core.
- The refractive index ( $n$ ) profile with reference to the radial distance ( $r$ ) from the fiber axis is given as:

## Graded index fiber

when  $r = 0$ ,  $n(r) = n_1$

$r < a$ ,  $n(r) =$

$$n_1 \left[ 1 - \left( 2 \Delta \left[ \frac{r}{a} \right]^2 \right) \right]^{\frac{1}{2}}$$

$$r \geq a, n(r) = n_2 = n_1 (1 - 2\Delta)^{\frac{1}{2}}$$

At the fiber centre we have  $n_1$ ; at the cladding we have  $n_2$ ; and in between we have  $n(r)$ , where  $n$  is the function of the particular radius as shown in Fig. simulates the change in  $n$  in a stepwise manner.

# Graded index fiber

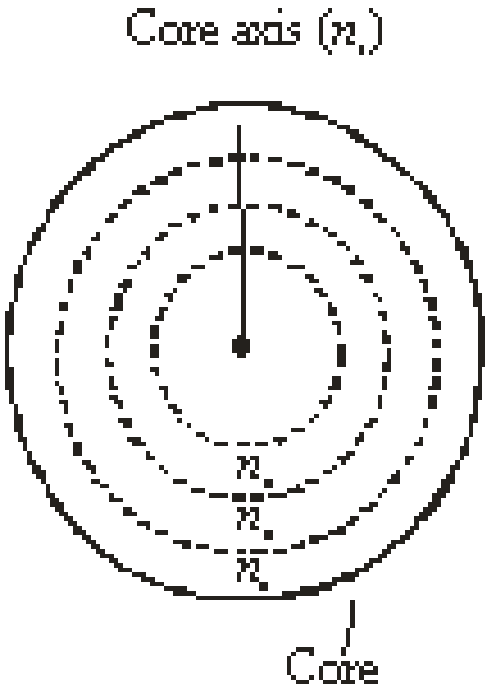
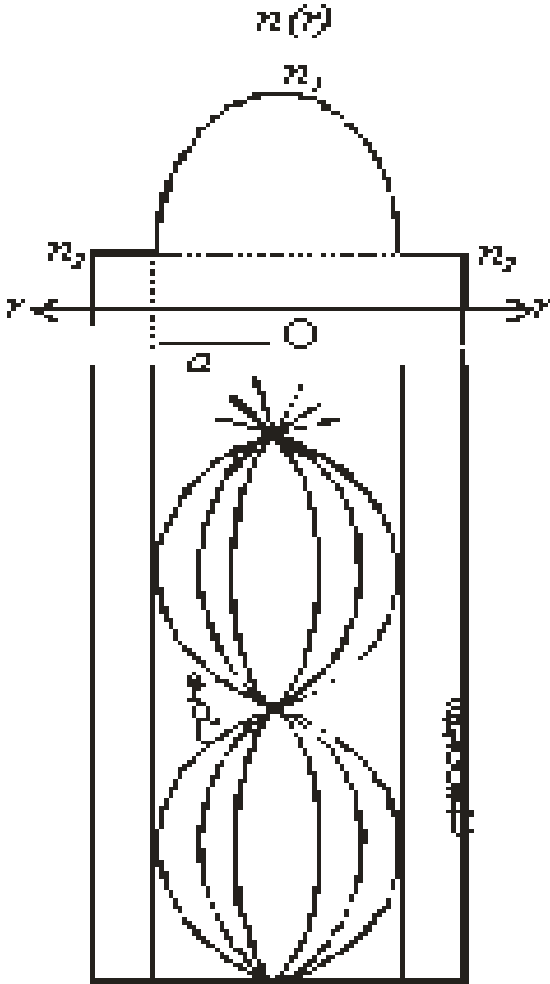

## Graded index fiber

- Each dashed circle represents a different refractive index, decreasing as we move away from the fiber center.
- A ray incident on these boundaries between  $n_a - n_b$ ,  $n_b - n_c$  etc., is refracted.
- Eventually at  $n_2$  the ray is turned around and totally reflected.
- This continuous refraction yields the ray tracings as shown in Fig.

## Graded index fiber

- The light rays will be propagated in the form skew rays (or) helical rays which will not cross the fiber axis at any time and are propagating around the fiber axis in a helical or spiral manner.
- The effective acceptance angle of the graded-index fiber is somewhat less than that of an equivalent step-index fiber. This makes coupling fiber to the light source more difficult.

## **UNIT-II**

### **SIGNAL DEGRADATION IN OPTICAL FIBER**

- Attenuation – Absorption losses, Scattering losses, Bending Losses, Core and Cladding losses,
- Signal Distortion in Optical Wave guides – Information Capacity determination – Group Delay –
- Material Dispersion, Wave guide Dispersion,
- Signal distortion in SM fibers – Polarization Mode dispersion, Intermodal dispersion,
- Pulse Broadening in GI fibers
- Mode Coupling – Design Optimization of SM fibers – RI profile and cut-off wavelength.

## Signal Attenuation & Distortion in Optical Fibers

- What are the loss or signal attenuation mechanism in a fiber?
- Why & to what degree do optical signals get distorted as they propagate down a fiber?
- Signal attenuation (fiber loss) largely determines the maximum repeaterless separation between optical transmitter & receiver.
- Signal distortion cause that optical pulses to broaden as they travel along a fiber, the overlap between neighboring pulses, creating errors in the receiver output, resulting in the limitation of information-carrying capacity of a fiber.

## Attenuation (fiber loss)

- Power loss along a fiber:



$$P(z) = P(0)e^{-\alpha_p z} \quad [3-1]$$

- The parameter  $\alpha_p$  is called fiber attenuation coefficient in a units of for example  $[1/\text{km}]$  or  $[\text{nepers}/\text{km}]$ . A more common unit is  $[\text{dB}/\text{km}]$  that is defined by:

$$\alpha[\text{dB}/\text{km}] = \frac{10}{l} \log \left[ \frac{P(0)}{P(l)} \right] = 4.343 \alpha_p [1/\text{km}] \quad [3-2]$$



## Fiber loss in dB/km

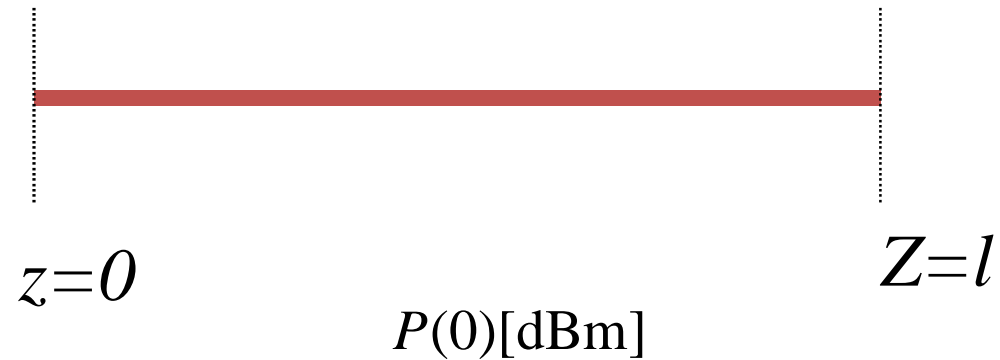

$$P(l)[\text{dBm}] = P(0)[\text{dBm}] - \alpha[\text{dB/km}] \times l[\text{km}] \quad [3-3]$$

- Where  $[\text{dBm}]$  or dB milliwatt is  $10\log(P [\text{mW}])$ .

# Optical fiber attenuation vs. wavelength

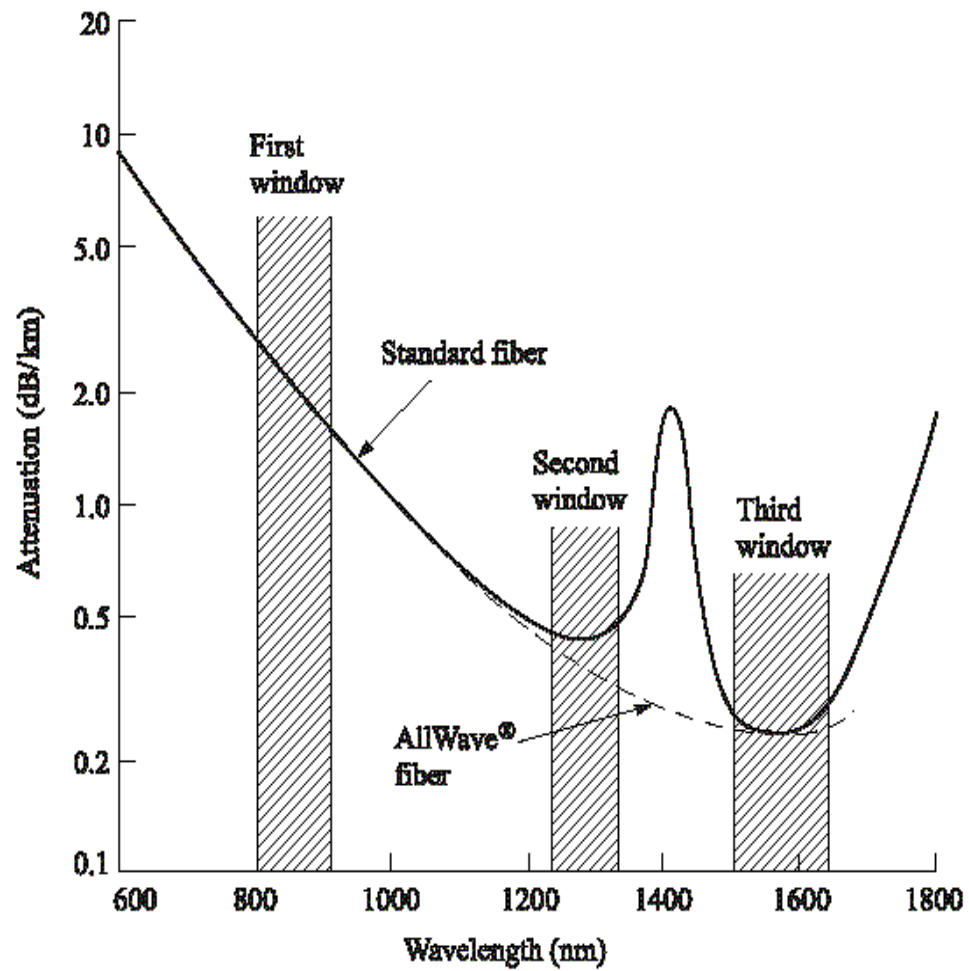

# Absorption

- Absorption is caused by three different mechanisms:
  - 1- Impurities in fiber material: from transition metal ions (must be in order of ppb) & particularly from OH ions with absorption peaks at wavelengths 2700 nm, 400 nm, 950 nm & 725nm.
  - 2- Intrinsic absorption (fundamental lower limit): electronic absorption band (UV region) & atomic bond vibration band (IR region) in basic SiO<sub>2</sub>.
  - 3- Radiation defects

## Scattering Loss

- Small (compared to wavelength) variation in material density, chemical composition, and structural inhomogeneity scatter light in other directions and absorb energy from guided optical wave.
- The essential mechanism is the Rayleigh scattering. Since the black body radiation classically is proportional to  $\lambda^{-4}$  (this is true for wavelength typically greater than 5 micrometer), the attenuation coefficient due to Rayleigh scattering is approximately proportional to  $\lambda^{-4}$ .

This seems to me not precise, where the attenuation of fibers at 1.3 & 1.55 micrometer can be exactly predicted with Planck's formula & can not be described with Rayleigh-Jeans law. Therefore I believe that the more accurate formula for scattering loss is

$$\alpha_{scat} \propto \lambda^{-5} \left[ \exp\left( \frac{hc}{\lambda k_B T} \right) \right]^{-1}$$

$$h = 6.626 \times 10^{-34} \text{ Js}, \quad k_B = 1.3806 \times 10^{-23} \text{ JK}^{-1}, \quad T : \text{Temperature}$$

# Absorption & scattering losses in fibers

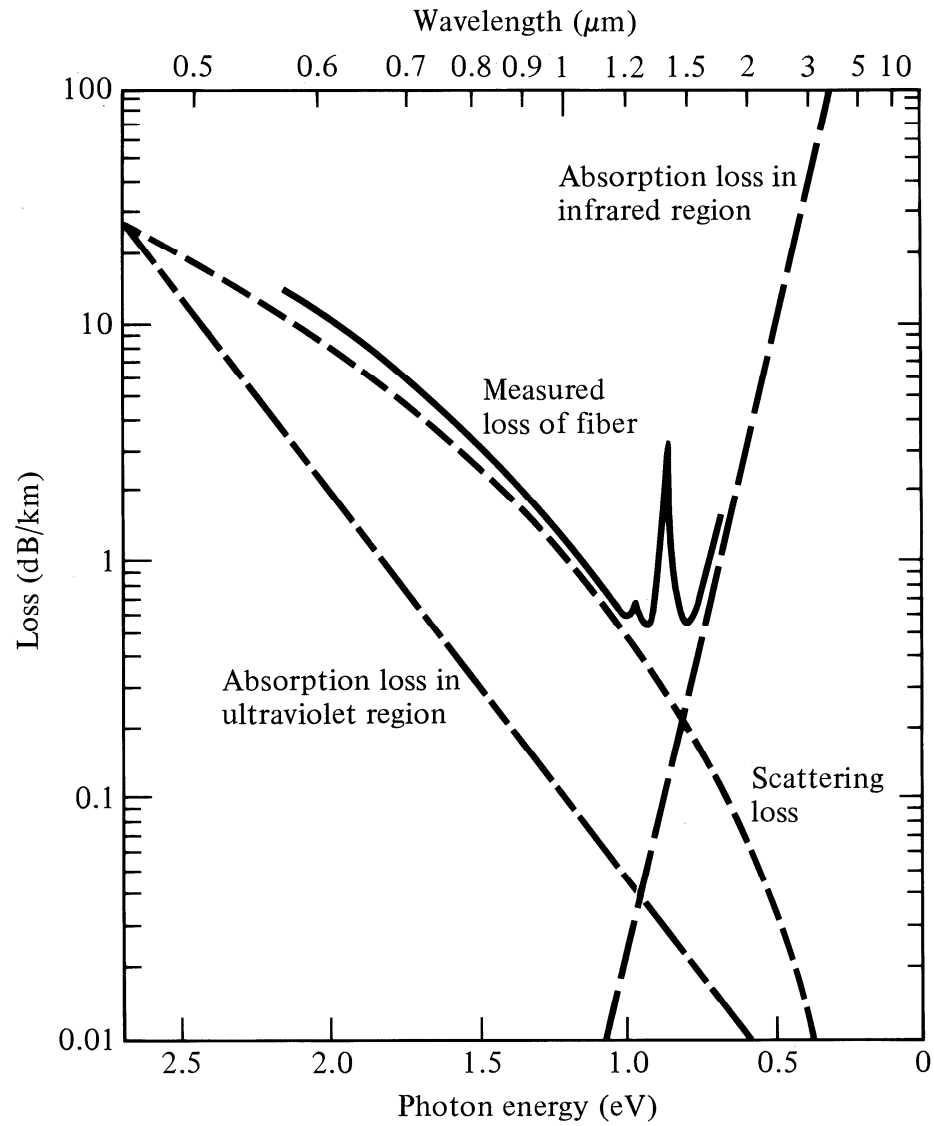

# Typical spectral absorption & scattering attenuations for a single mode-fiber

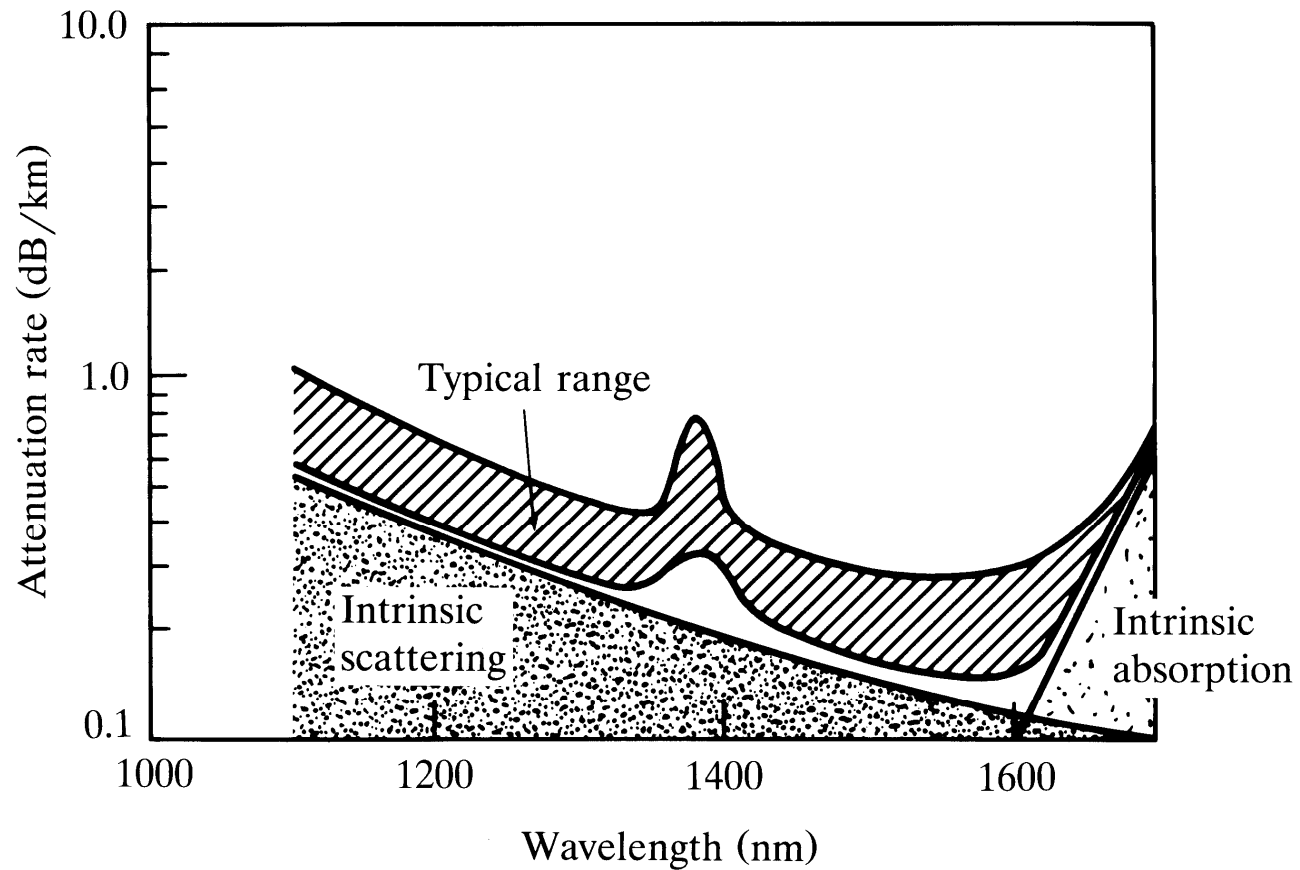

## Bending Loss (Macrobending & Microbending)

- **Macrobending Loss:** The curvature of the bend is much larger than fiber diameter. Lightwave suffers sever loss due to radiation of the evanescent field in the cladding region. As the radius of the curvature decreases, the loss increases exponentially until it reaches at a certain critical radius. For any radius a bit smaller than this point, the losses suddenly becomes extremely large. Higher order modes radiate away faster than lower order modes.



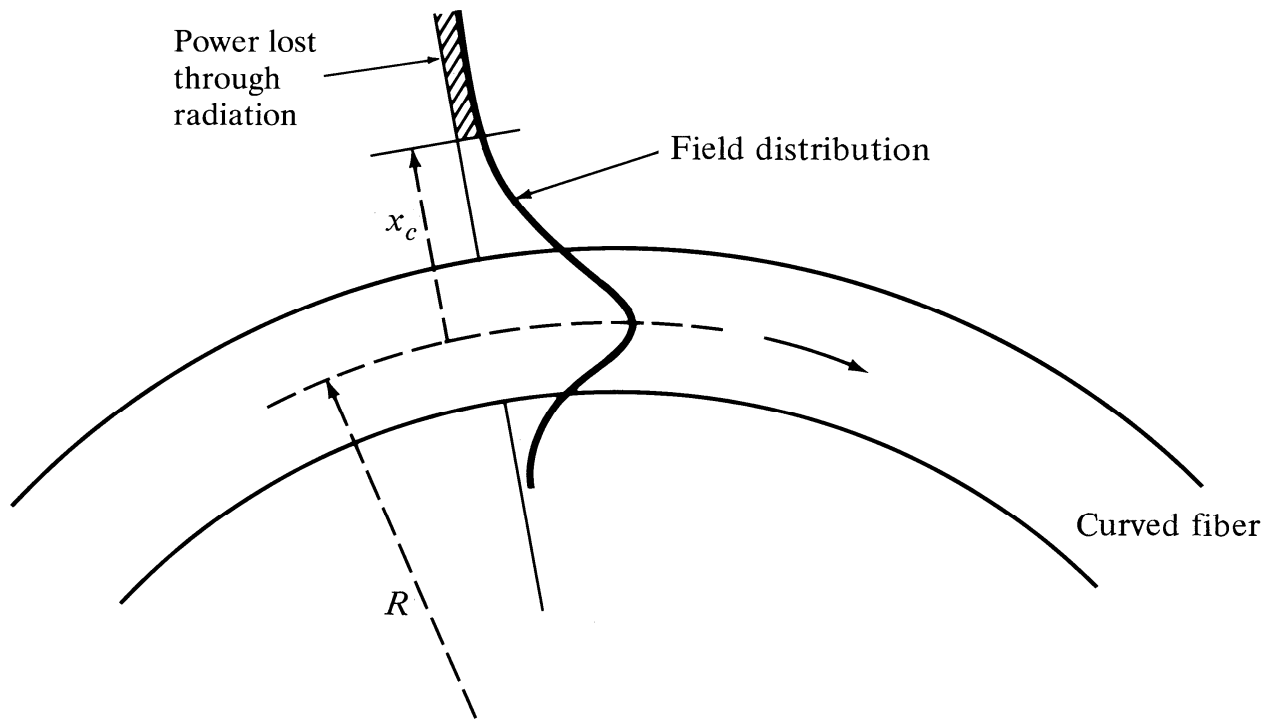

# Microbending Loss

## Microbending Loss:

microscopic bends of the fiber axis that can arise when the fibers are incorporated into cables. The power is dissipated through the microbended fiber, because of the repetitive coupling of energy between guided modes & the leaky or radiation modes in the fiber.

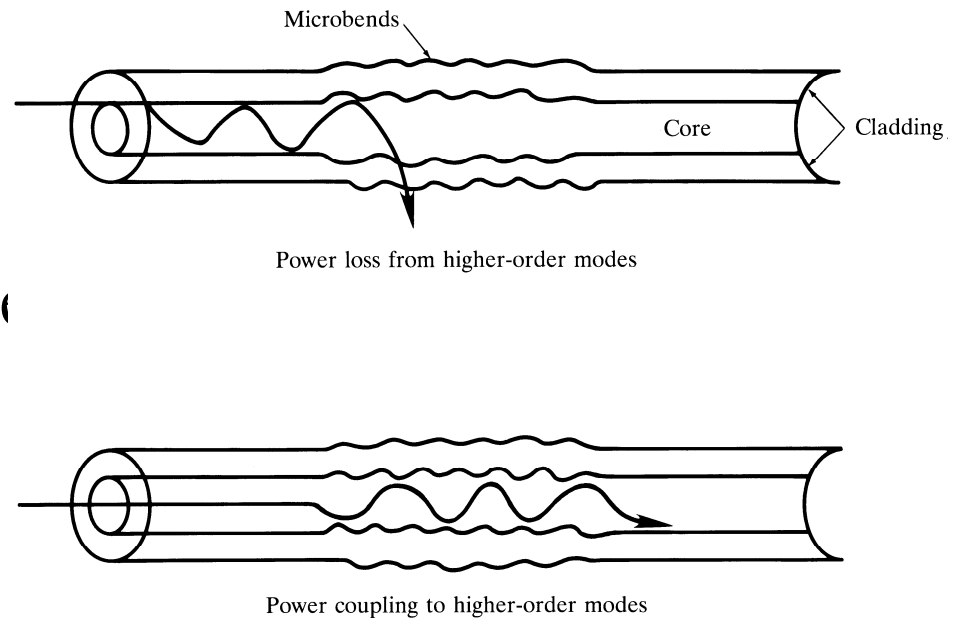

## Dispersion in Optical Fibers

- **Dispersion:** Any phenomenon in which the velocity of propagation of any electromagnetic wave is wavelength dependent.
- In communication, dispersion is used to describe any process by which any electromagnetic signal propagating in a physical medium is degraded because the various wave characteristics (i.e., frequencies) of the signal have different propagation velocities within the physical medium.

There are 3 dispersion types in the optical fibers, in general:

- 1- Material Dispersion**
- 2- Waveguide Dispersion**
- 3- Polarization-Mode**

## **Dispersion**

Material & waveguide dispersions are main causes of Intramodal Dispersion.

## Group Velocity

- Wave Velocities:
- **1- Plane wave velocity:** For a plane wave propagating along  $z$ -axis in an unbounded homogeneous region of refractive index  $n_1$ , which is represented by  $\exp(j\omega t - jk_1 z)$ , the velocity of constant phase plane is:

$$v = \frac{\omega}{k_1} = \frac{c}{n_1} \quad [3-4]$$

$$v_p = \frac{\omega}{\beta} \quad [3-5]$$

- **2- Modal wave phase velocity:** For a modal wave propagating along  $z$ -axis represented by  $\exp(j\omega t - jk_1 z)$ , the velocity of constant phase plane is:

3- For transmission system operation the most important & useful type of velocity is the **group velocity**,  $v_g$ . This is the actual velocity which the signal information & energy is traveling down the fiber. It is always less than the speed of light in the medium. The observable delay experienced by the optical signal waveform & energy, when traveling a length of  $l$  along the fiber is commonly referred to as **group delay**.

## Group Velocity & Group Delay

- The group velocity is given by:

$$V_g = \frac{d\omega}{d\beta} \quad [3-6]$$

- The group delay is given by:

$$\tau_g = \frac{l}{V_g} = l \frac{d\beta}{d\omega} \quad [3-7]$$

- It is important to note that all above quantities depend both on **frequency** & the **propagation mode**. In order to see the effect of these parameters on group velocity and delay, the following analysis would be helpful.

## Input/Output signals in Fiber Transmission System

- The optical signal (complex) waveform at the input of fiber of length  $l$  is  $f(t)$ . The propagation constant of a particular modal wave carrying the signal is  $\beta(\omega)$ . Let us find the output signal waveform  $g(t)$ .

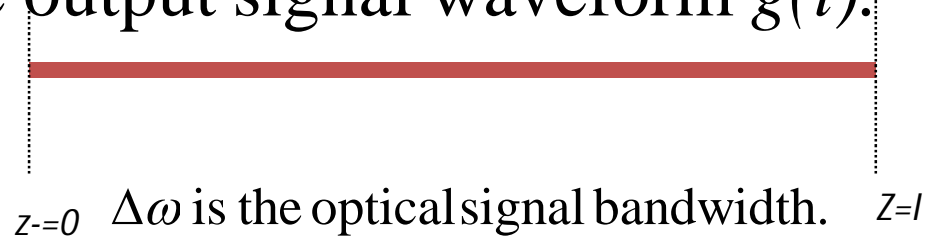

$$f(t) = \int_{\omega_c - \Delta\omega}^{\omega_c + \Delta\omega} \tilde{f}(\omega) e^{j\omega t} d\omega \quad [3-8]$$

$$g(t) = \int_{\omega_c - \Delta\omega}^{\omega_c + \Delta\omega} \tilde{f}(\omega) e^{j\omega t - j\beta(\omega)l} d\omega \quad [3-9]$$



If  $\Delta\omega \ll \omega_c$

$$\beta(\omega) = \beta(\omega_c) + \left. \frac{d\beta}{d\omega} \right|_{\omega=\omega_c} (\omega - \omega_c) + \frac{1}{2} \left. \frac{d^2\beta}{d\omega^2} \right|_{\omega=\omega_c} (\omega - \omega_c)^2 + \dots \quad [3-10]$$

$$g(t) = \int_{\omega_c - \Delta\omega/2}^{\omega_c + \Delta\omega/2} \tilde{f}(\omega) e^{j\omega t - j\beta(\omega)l} d\omega \approx \int_{\omega_c - \Delta\omega/2}^{\omega_c + \Delta\omega/2} \tilde{f}(\omega) e^{j\omega t - j[\beta(\omega_c) + \left. \frac{d\beta}{d\omega} \right|_{\omega=\omega_c} (\omega - \omega_c)]l} d\omega$$

$$\approx e^{-j\beta(\omega_c)l} \int_{\omega_c - \Delta\omega/2}^{\omega_c + \Delta\omega/2} \tilde{f}(\omega) e^{j\omega(t - l \left. \frac{d\beta}{d\omega} \right|_{\omega=\omega_c})} d\omega$$

$$= e^{-j\beta(\omega_c)l} f\left(t - l \left. \frac{d\beta}{d\omega} \right|_{\omega=\omega_c}\right) = e^{-j\beta(\omega_c)l} f(t - \tau_g) \quad [3-11]$$

$$\tau_g = l \left. \frac{d\beta}{d\omega} \right|_{\omega=\omega_c} = \frac{l}{V_g} \quad [3-14]$$

## Intramodal Dispersion

- As we have seen from Input/output signal relationship in optical fiber, the output is proportional to the delayed version of the input signal, and the delay is inversely proportional to the group velocity of the wave. Since the propagation constant,  $\Delta\omega$ , is frequency dependent over band width  $\beta(\omega)$  sitting at the center frequency  $\omega_c$ , at each frequency, we have one propagation constant resulting in a specific delay time.

As the output signal is collectively represented by group velocity & group delay this phenomenon is called intramodal dispersion or Group Velocity Dispersion (GVD). This phenomenon arises due to a finite bandwidth of the optical source, dependency of refractive index on the wavelength and the modal dependency of the group velocity.

In the case of optical pulse propagation down the fiber, GVD causes pulse broadening, leading to Inter Symbol Interference (ISI).

# Dispersion & ISI

A measure of information capacity of an optical fiber for digital transmission is usually specified by the bandwidth distance product in GHz.km. For multi-mode step index fiber this quantity is about 20 MHz.km, for graded index fiber is about 2.5 GHz.km & for single mode fibers are higher than 10 GHz.km.

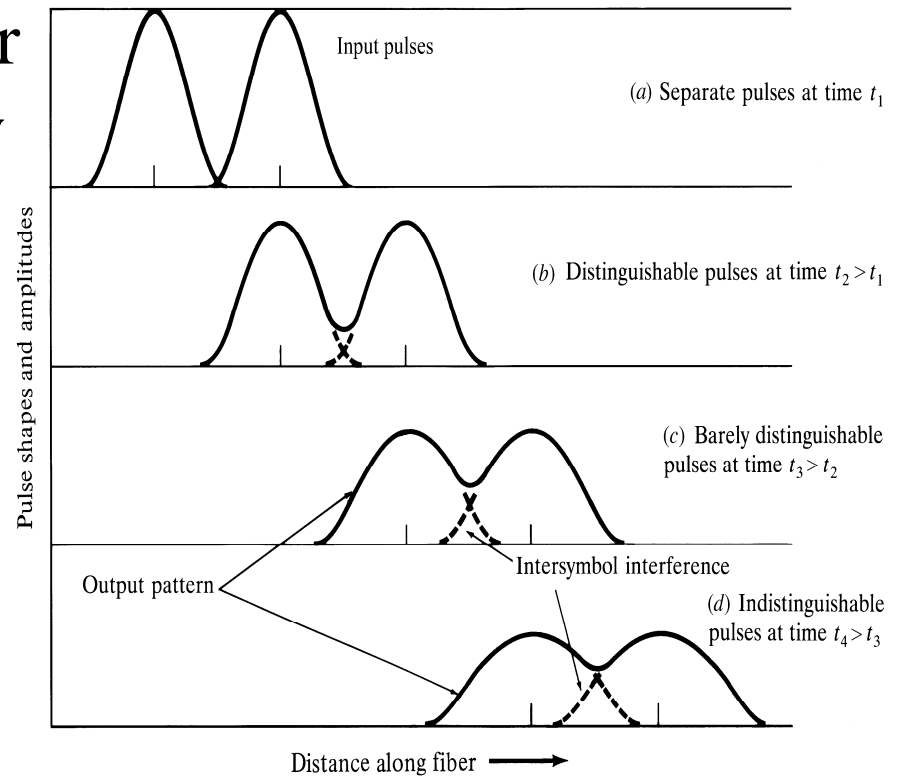

$$BW \times L$$

## How to characterize dispersion?

- Group delay per unit length can be defined as:

$$\frac{\tau_g}{L} = \frac{d\beta}{d\omega} = \frac{1}{c} \frac{d\beta}{dk} = -\frac{\lambda^2}{2\pi c} \frac{d\beta}{d\lambda} \quad [3-15]$$

- If the spectral width of the optical source is not too wide, then the delay difference per unit wavelength  $\delta\lambda$  along the propagation path is approximately For spectral components which are  $\delta\tau$  apart, symmetrical around center wavelength, the total delay difference over a distance  $L$  is:  $\frac{d\tau_g}{d\lambda}$

- $\beta_2 \equiv \frac{d^2\beta}{d\omega^2}$  is called GVD parameter, and shows how much a light pulse broadens as it travels along an optical fiber. The more common parameter is called Dispersion, and can be defined as the delay difference per unit length per unit wavelength as follows:

$$D = \frac{1}{L} \frac{d\tau_g}{d\lambda} = \frac{d}{d\lambda} \left( \frac{1}{V_g} \right) = -\frac{2\pi c}{\lambda^2} \beta_2 \quad [3-17]$$

- In the case of optical pulse, if the spectral width of the optical source is characterized by its rms value of the Gaussian pulse  $\sigma_\lambda$ , the pulse spreading over the length of L,  $\sigma_g$  can be well approximated by:

$$\sigma_g \approx \left| \frac{d\tau_g}{d\lambda} \right| \sigma_\lambda = DL\sigma_\lambda \quad [3-18]$$

# Material Dispersion

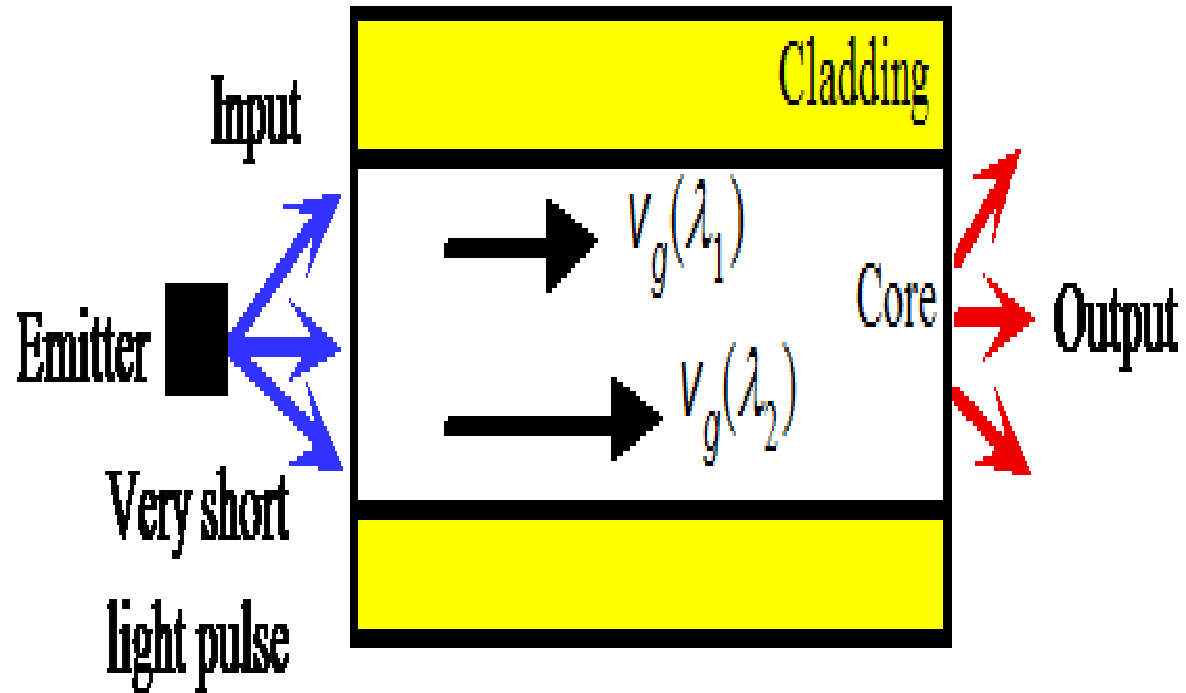

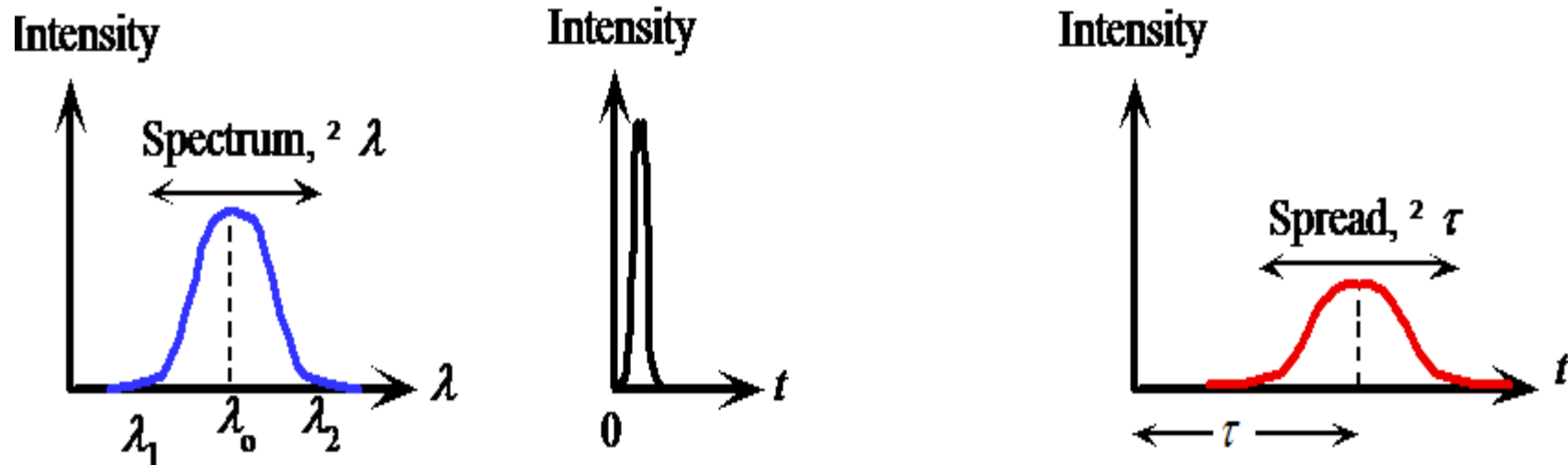

All excitation sources are inherently non-monochromatic and emit within a spectrum,  $^2 \lambda$ , of wavelengths. Waves in the guide with different free space wavelengths travel at different group velocities due to the wavelength dependence of  $n_1$ . The waves arrive at the end of the fiber at different times and hence result in a broadened output pulse.



# Material Dispersion

- The refractive index of the material varies as a function of wavelength,  $n(\lambda)$
- Material-induced dispersion for a plane wave propagation in homogeneous medium of refractive index  $n$ :

$$\begin{aligned}\tau_{mat} &= L \frac{d\beta}{d\omega} = -\frac{\lambda^2}{2\pi c} L \frac{d\beta}{d\lambda} = -\frac{\lambda^2}{2\pi c} L \frac{d}{d\lambda} \left[ \frac{2\pi}{\lambda} n(\lambda) \right] \\ &= \frac{L}{c} \left( n - \lambda \frac{dn}{d\lambda} \right)\end{aligned}\quad [3-19]$$

- The pulse spread due to material dispersion is therefore:

$$\sigma_g \approx \left| \frac{d\tau_{mat}}{d\lambda} \right| \sigma_\lambda = \frac{L\sigma_\lambda}{c} \left| \lambda \frac{d^2n}{d\lambda^2} \right| = L\sigma_\lambda |D_{mat}(\lambda)| \quad [3-20]$$

$D_{mat}(\lambda)$  is material dispersion

# Material Dispersion Diagrams

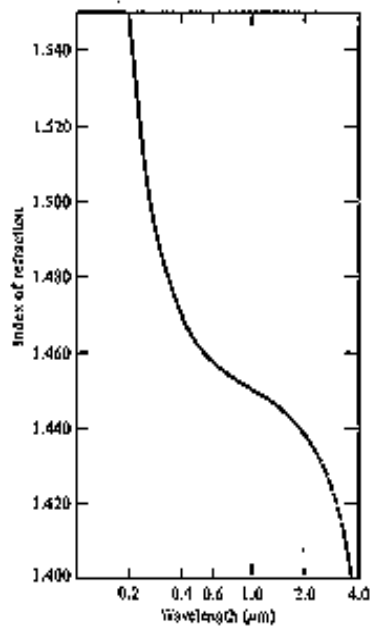

FIGURE 3-12  
Variations in the index of refraction as a function of the optical wavelength for silica. (Reproduced with permission from I. H. Malitson, *J. Opt. Soc. Amer.*, vol. 55, pp. 1205-1209, Oct. 1965.)

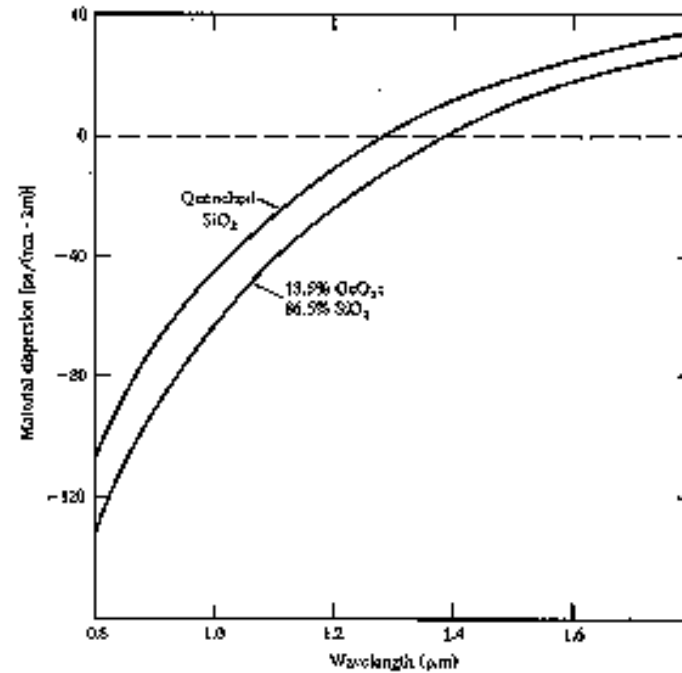

FIGURE 3-13  
Material dispersion as a function of optical wavelength for pure silica and 13.5 percent GeO<sub>2</sub>/86.5 percent SiO<sub>2</sub>. (Reproduced with permission from J. W. Fleming, *Electron. Lett.*, vol. 14, pp. 326-328, May 1978.)

## Waveguide Dispersion

- Waveguide dispersion is due to the dependency of the group velocity of the fundamental mode as well as other modes on the  $V$  number, (see Fig 2-18 of the textbook). In order to calculate waveguide dispersion, we consider that  $n$  is not dependent on wavelength. Defining the normalized propagation constant  $b$  as:

$$b = \frac{\beta^2 / k^2 - n_2^2}{n_1^2 - n_2^2} \approx \frac{\beta / k - n_2}{n_1 - n_2} \quad [3-21]$$

- solving for propagation constant:

$$\beta \approx n_2 k (1 + b\Delta) \quad [3-22]$$

- Using  $V$  number:  $V = ka(n_1^2 - n_2^2)^{1/2} \approx kan_2 \sqrt{2\Delta} \quad [3-23]$

# Waveguide Dispersion

- Delay time due to waveguide dispersion can then be

expressed as:

$$\tau_{wg} = \frac{L}{c} \left[ n_2 + n_2 \Delta \frac{d(Vb)}{dV} \right] \quad [3-24]$$

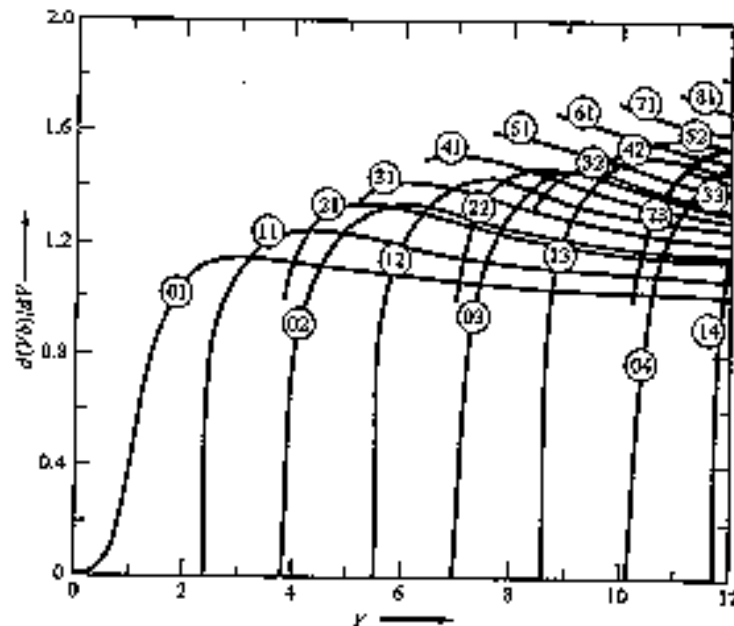

**FIGURE 3-14**  
The group delay arising from waveguide dispersion as a function of the  $V$  number for a step-index optical fiber. The curve numbers designate the  $LP_{lm}$  modes. (Reproduced with permission from Gloge.<sup>37</sup>)

## Waveguide dispersion in single mode fibers

- For single mode fibers, waveguide dispersion is in the same order of material dispersion. The pulse spread can be well approximated as:

$$\sigma_{wg} \approx \left| \frac{d\tau_{wg}}{d\lambda} \right| \sigma_{\lambda} = L \sigma_{\lambda} |D_{wg}(\lambda)| = \frac{n_2 L \Delta \sigma_{\lambda}}{c \lambda} V \frac{d^2(Vb)}{dV^2} \quad [3-25]$$

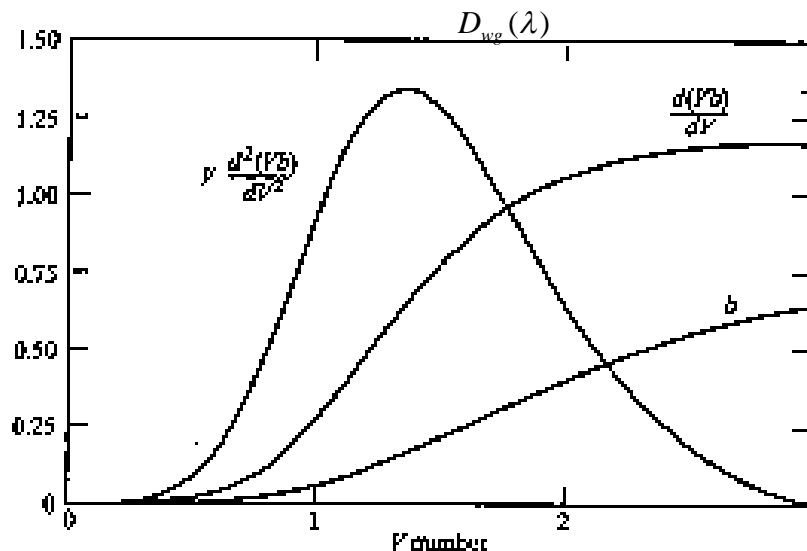
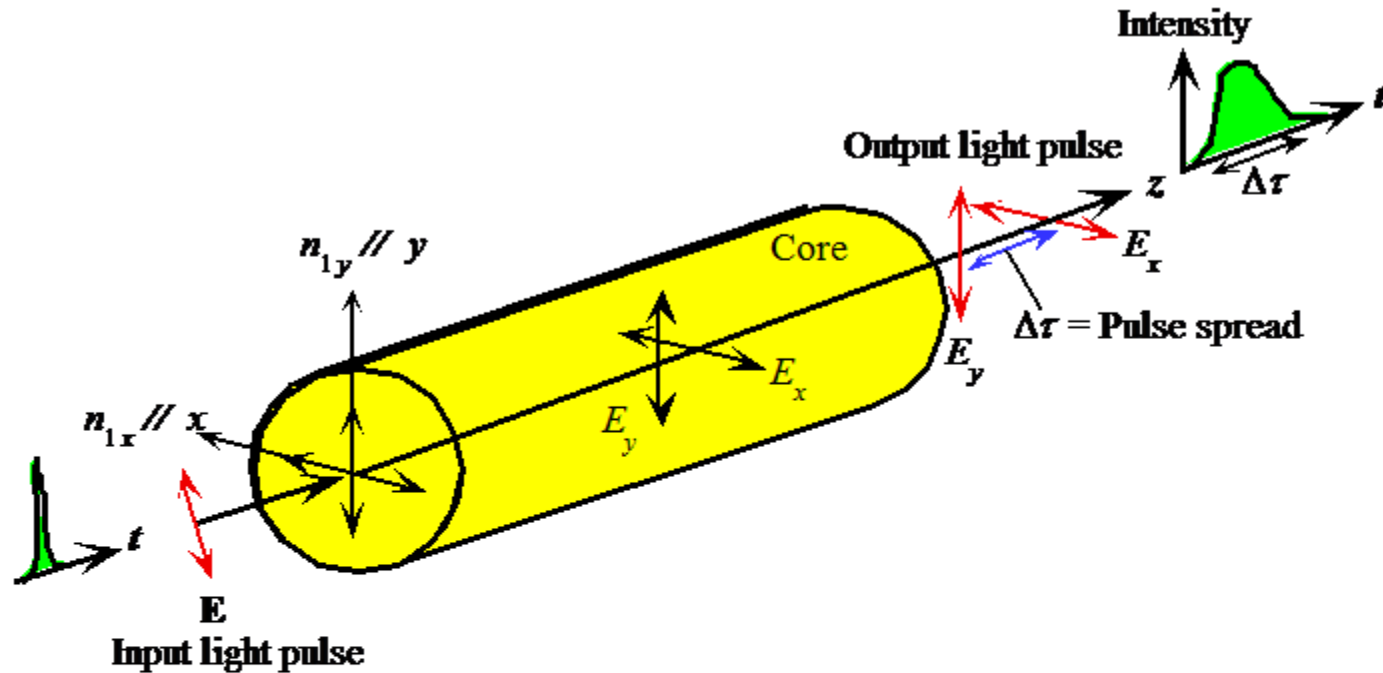

FIGURE 3-15

The waveguide parameter  $b$  and its derivatives  $d(Vb)/dV$  and  $V d^2(Vb)/dV^2$  plotted as a function of the  $V$  number for the  $HE_{11}$  mode.

# Polarization Mode dispersion



Suppose that the core refractive index has different values along two orthogonal directions corresponding to electric field oscillation direction (polarizations). We can take  $x$  and  $y$  axes along these directions. An input light will travel along the fiber with  $E_x$  and  $E_y$  polarizations having different group velocities and hence arrive at the output at different times

## Polarization Mode dispersion

- The effects of fiber-birefringence on the polarization states of an optical are another source of pulse broadening. **Polarization mode dispersion (PMD)** is due to slightly different velocity for each polarization mode because of the lack of perfectly symmetric & anisotropy of the fiber. If the group velocities of two orthogonal polarization modes are  $v_{gx}$  and  $v_{gy}$  then the differential time delay  $\Delta\tau_{pol}$  between these two polarization over a distance  $L$  is

$$\Delta\tau_{pol} = \left| \frac{L}{v_{gx}} - \frac{L}{v_{gy}} \right| \quad [3-26]$$

$$\langle \Delta\tau_{pol} \rangle \approx D_{PMD} \sqrt{L} \quad [3-27]$$
- The rms value of the differential group delay can be approximated as:

## Chromatic & Total Dispersion

- Chromatic dispersion includes the material & waveguide dispersions.

$$D_{ch}(\lambda) \approx |D_{mat} + D_{wg}|$$

[3-28]

$$\sigma_{ch} = D_{ch}(\lambda)L\sigma_{\lambda}$$

- Total dispersion is the sum of chromatic , polarization dispersion and other dispersion types and the total rms pulse spreading can be approximately written as:

$$D_{total} \approx |D_{ch} + D_{pol} + \dots|$$

[3-29]

$$\sigma_{total} = D_{total}L\sigma_{\lambda}$$



# Total Dispersion, zero Dispersion

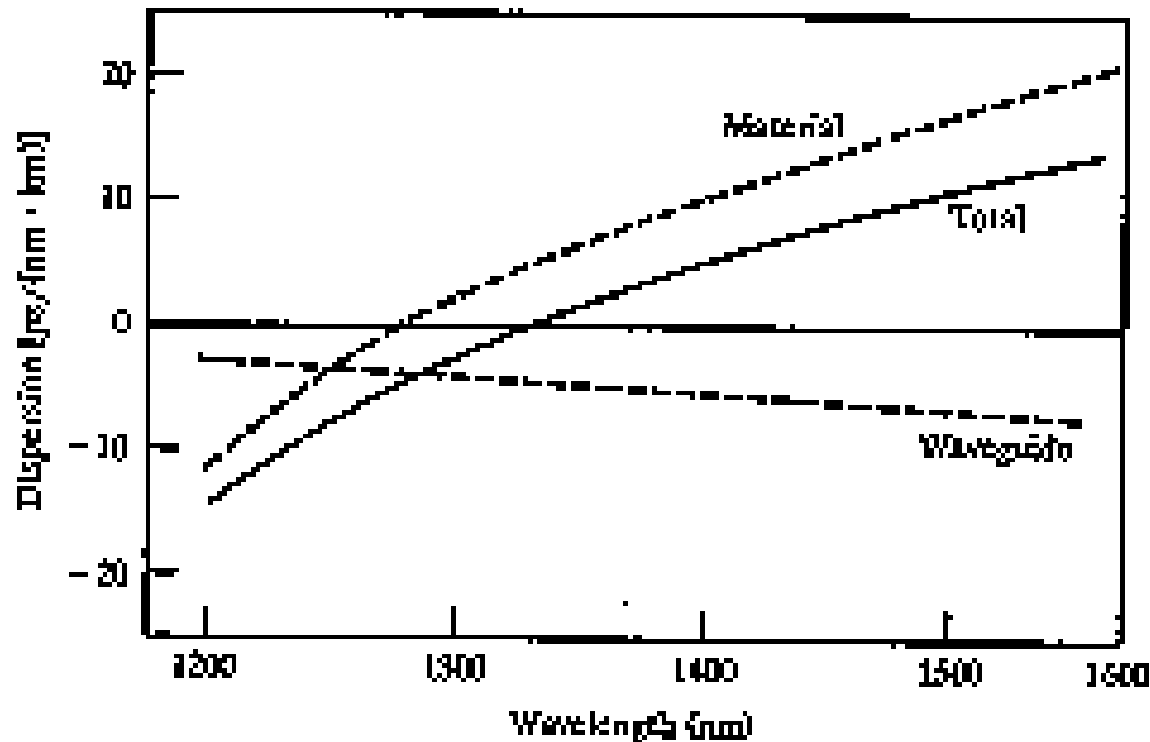

**FIGURE 3-16**

Examples of the magnitudes of material and waveguide dispersion as a function of optical wavelength for a single-mode fused-silica-core fiber. (Reproduced with permission from Keck,<sup>16</sup> © 1985, IEEE.)

Fact 1) Minimum distortion at wavelength about 1300 nm for single mode silica fiber.

Fact 2) Minimum attenuation is at 1550 nm for single mode silica fiber.

Strategy: shifting the zero-dispersion to longer wavelength for minimum attenuation and dispersion.

## Optimum single mode fiber & distortion/attenuation characteristics

Fact 1) Minimum distortion at wavelength about 1300 nm for single mode silica fiber.

Fact 2) Minimum attenuation is at 1550 nm for single mode silica fiber.

Strategy: shifting the zero-dispersion to longer wavelength for minimum attenuation and dispersion by Modifying waveguide dispersion by changing from a simple step-index core profile to more complicated profiles.

There are four major categories to do that:

1- 1300 nm optimized single mode step-fibers: matched cladding (mode diameter 9.6 micrometer) and depressed-cladding (mode diameter about 9 micrometer)

2- Dispersion shifted fibers.

3- Dispersion-flattened fibers.

4- Large-effective area (LEA) fibers (less non linearities for fiber optical amplifier applications, effective cross section areas are typically greater than  $100 \mu\text{m}^2$  ).

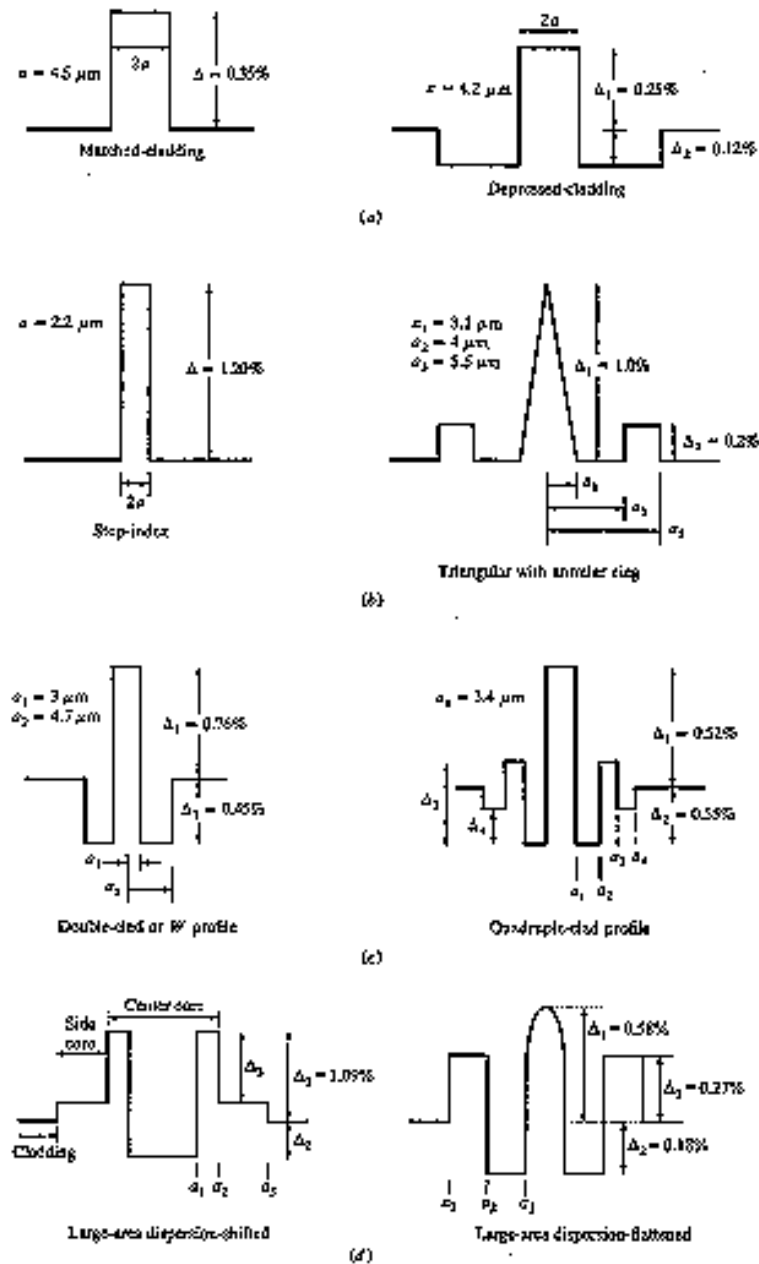
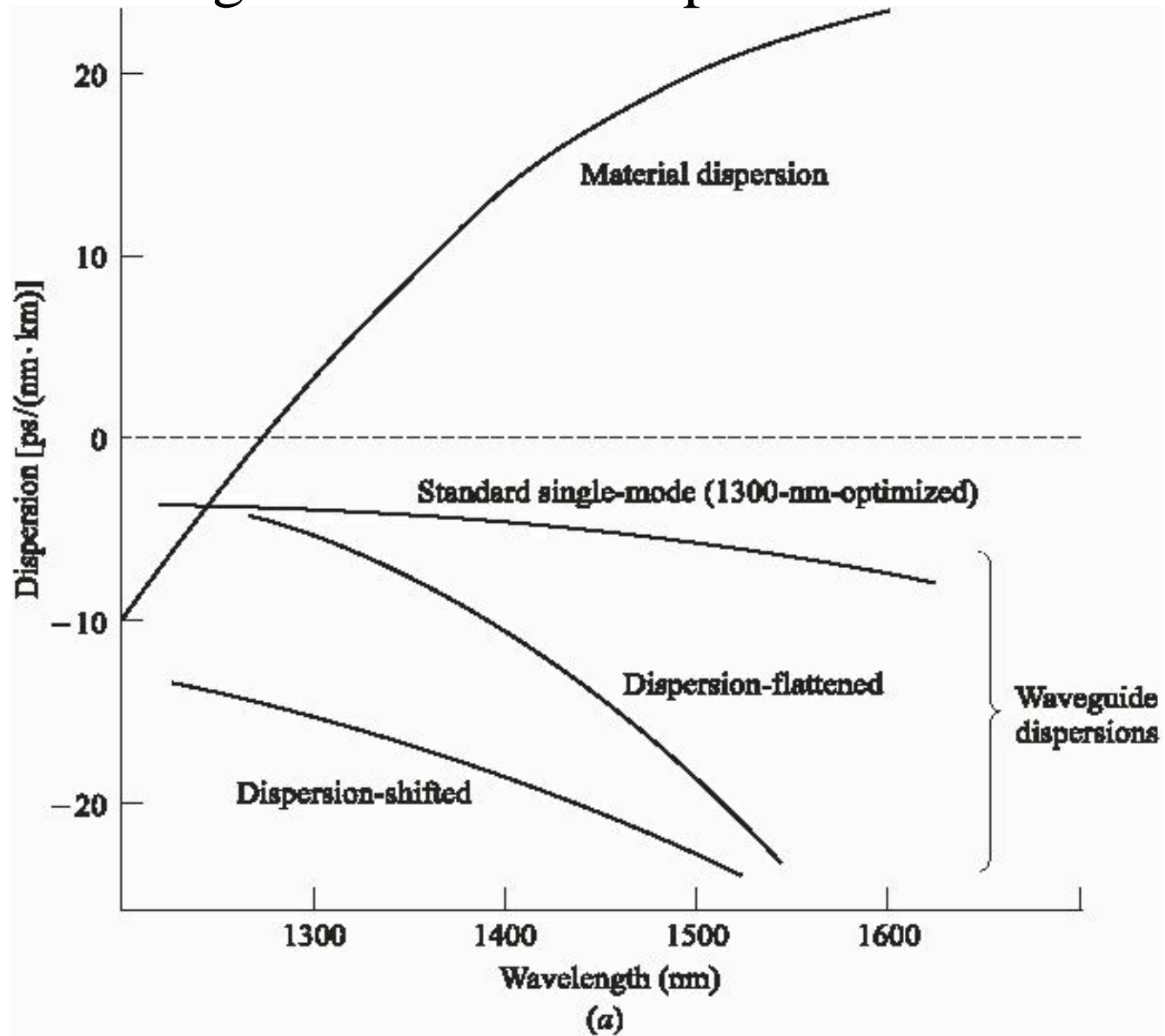

FIGURE 3-22

Representative cross sections of index profiles for (a) 1500-nm-optimized, (b) dispersion-shifted, (c) dispersion-flattened, and (d) large-effective-core-area fibers.

# Single mode fiber dispersion



# Single mode fiber dispersion

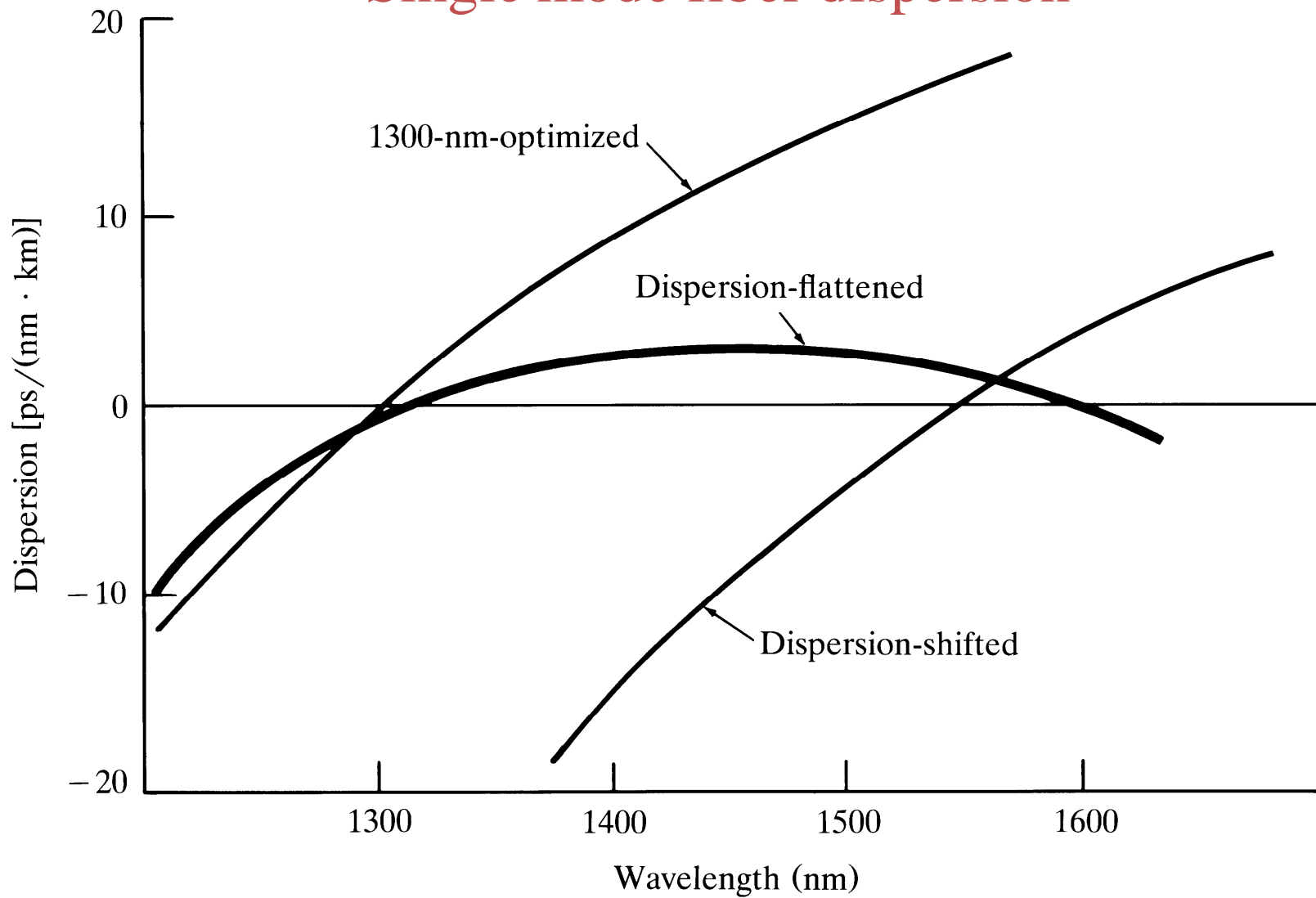

(b)

## Single mode Cut-off wavelength & Dispersion

- Fundamental mode is  $HE_{11}$  or  $LP_{01}$
- with  $V=2.405$  and  $\lambda_c = \frac{2\pi a}{V} \sqrt{n_1^2 - n_2^2}$  [3-30]

- Dispersion: [3-31]

$$D(\lambda) = \frac{d\tau}{d\lambda} \approx D_{mat}(\lambda) + D_{wg}(\lambda) \quad [3-32]$$

$$\sigma = D(\lambda)L\sigma_\lambda$$

- For non-dispersion-shifted fibers (1270 nm – 1340 nm)
- For dispersion shifted fibers (1500 nm- 1600 nm)

## Dispersion for non-dispersion-shifted fibers (1270 nm – 1340 nm)

$$\tau(\lambda) = \tau_0 + \frac{S_0}{8} \left( \lambda - \frac{\lambda_0^2}{\lambda} \right)^2 \quad [3-33]$$

- $\tau_0$  is relative delay minimum at the zero-dispersion wavelength  $\lambda_0$ , and  $S_0$  is the value of the dispersion slope in ps/(nm<sup>2</sup>.km).

$$S_0 = S(\lambda_0) = \left. \frac{dD}{d\lambda} \right|_{\lambda=\lambda_0} \quad [3-34]$$

$$D(\lambda) = \frac{\lambda S_0}{4} \left[ 1 - \left( \frac{\lambda_0}{\lambda} \right)^4 \right] \quad [3-35]$$



Dispersion for dispersion shifted fibers(1500 nm- 1600 nm)

$$\tau(\lambda) = \tau_0 + \frac{S_0}{2}(\lambda - \lambda_0)^2 \quad [3-36]$$

$$D(\lambda) = (\lambda - \lambda_0)S_0 \quad [3-37]$$

Example of dispersion  
Performance curve for  
Set of SM-fiber

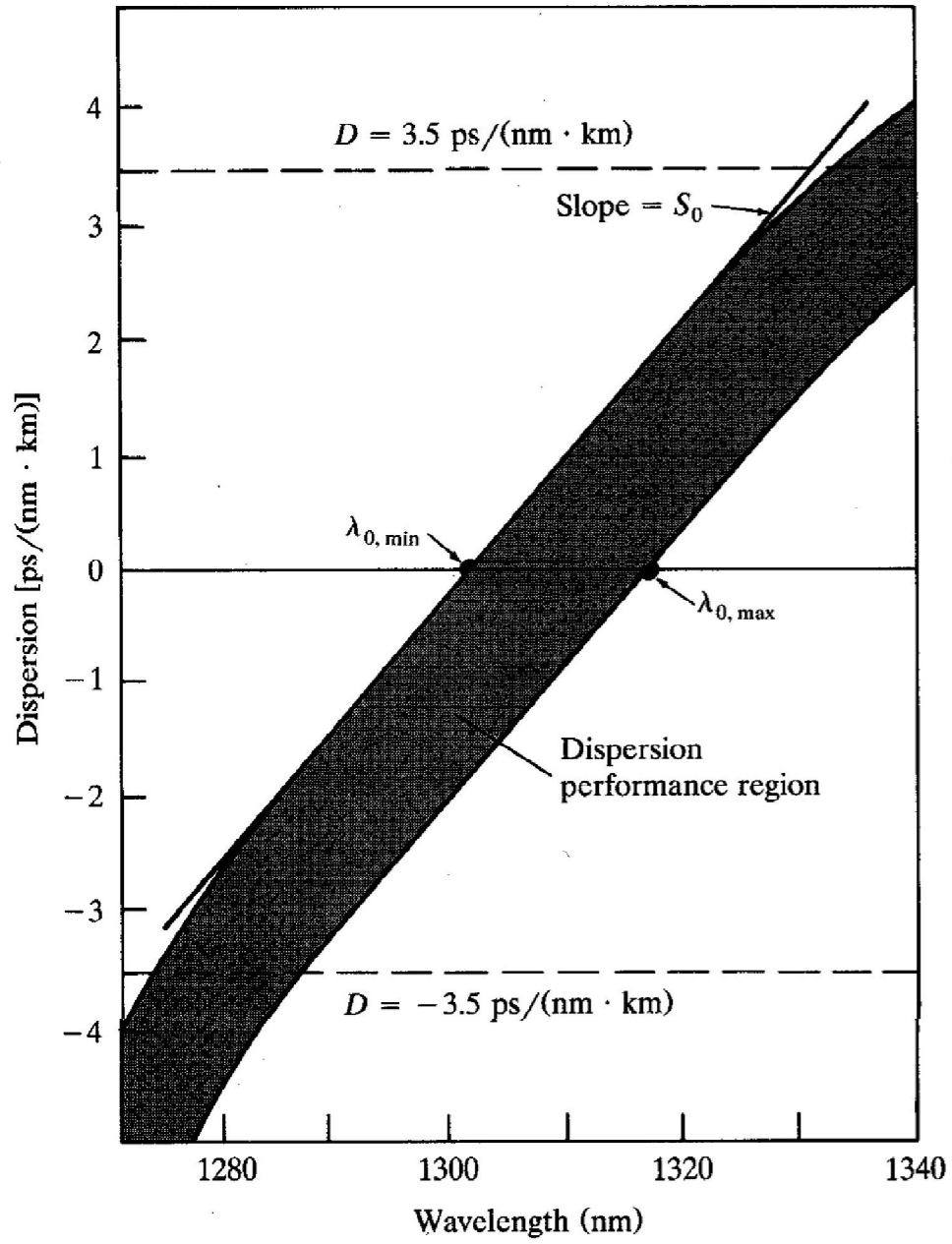

Example of BW vs wavelength for various optical sources for SM-fiber.

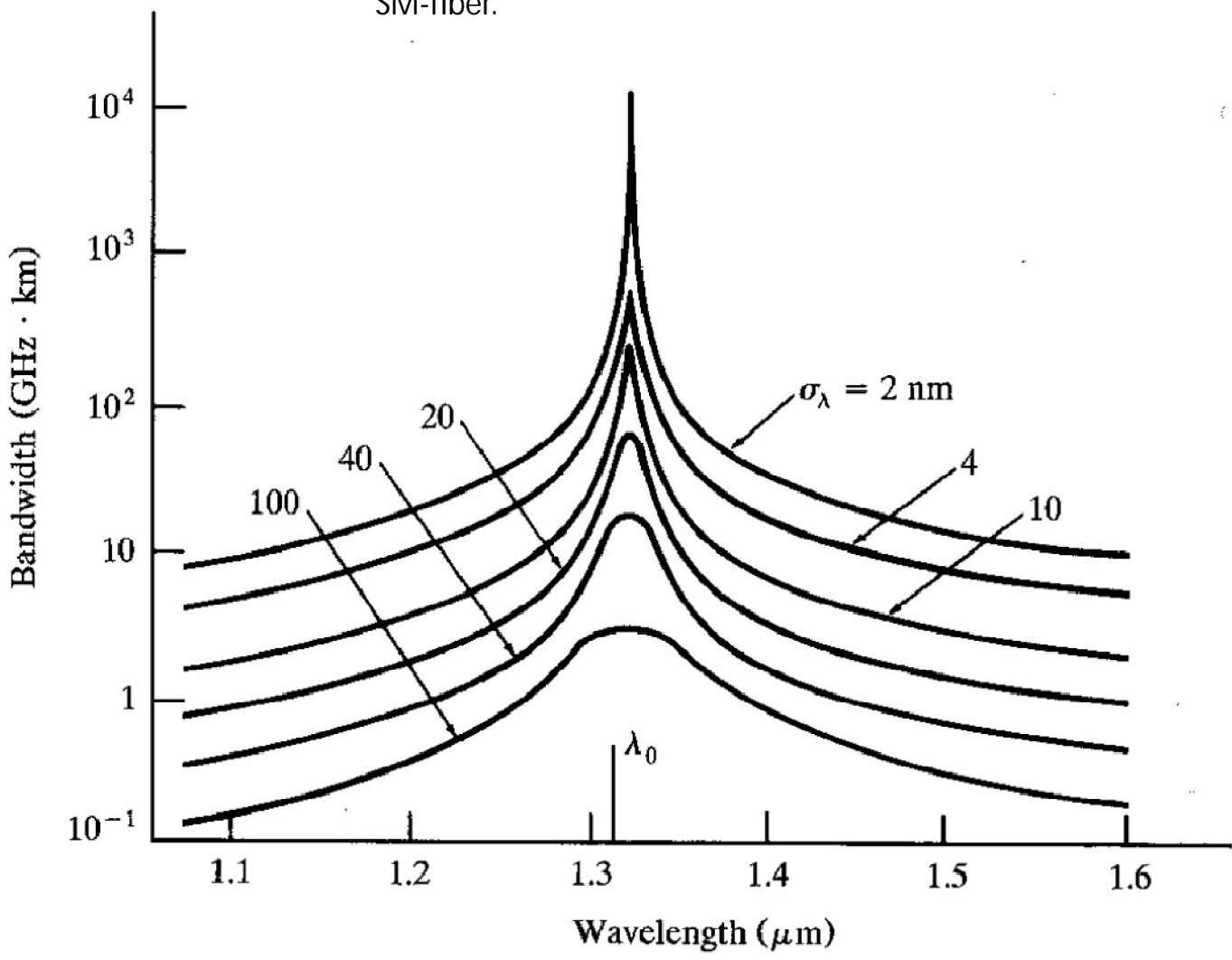

# MFD

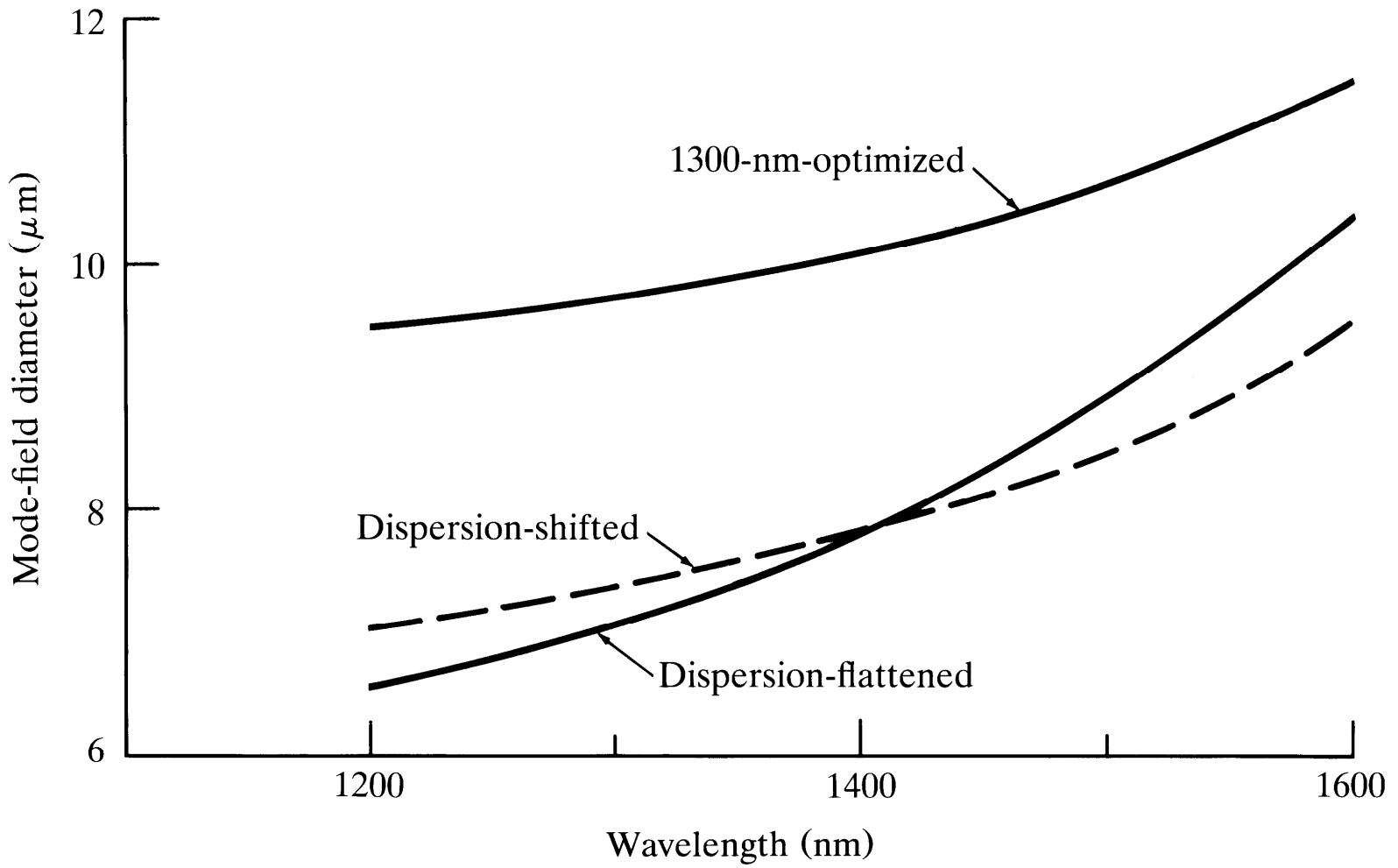

# Bending Loss

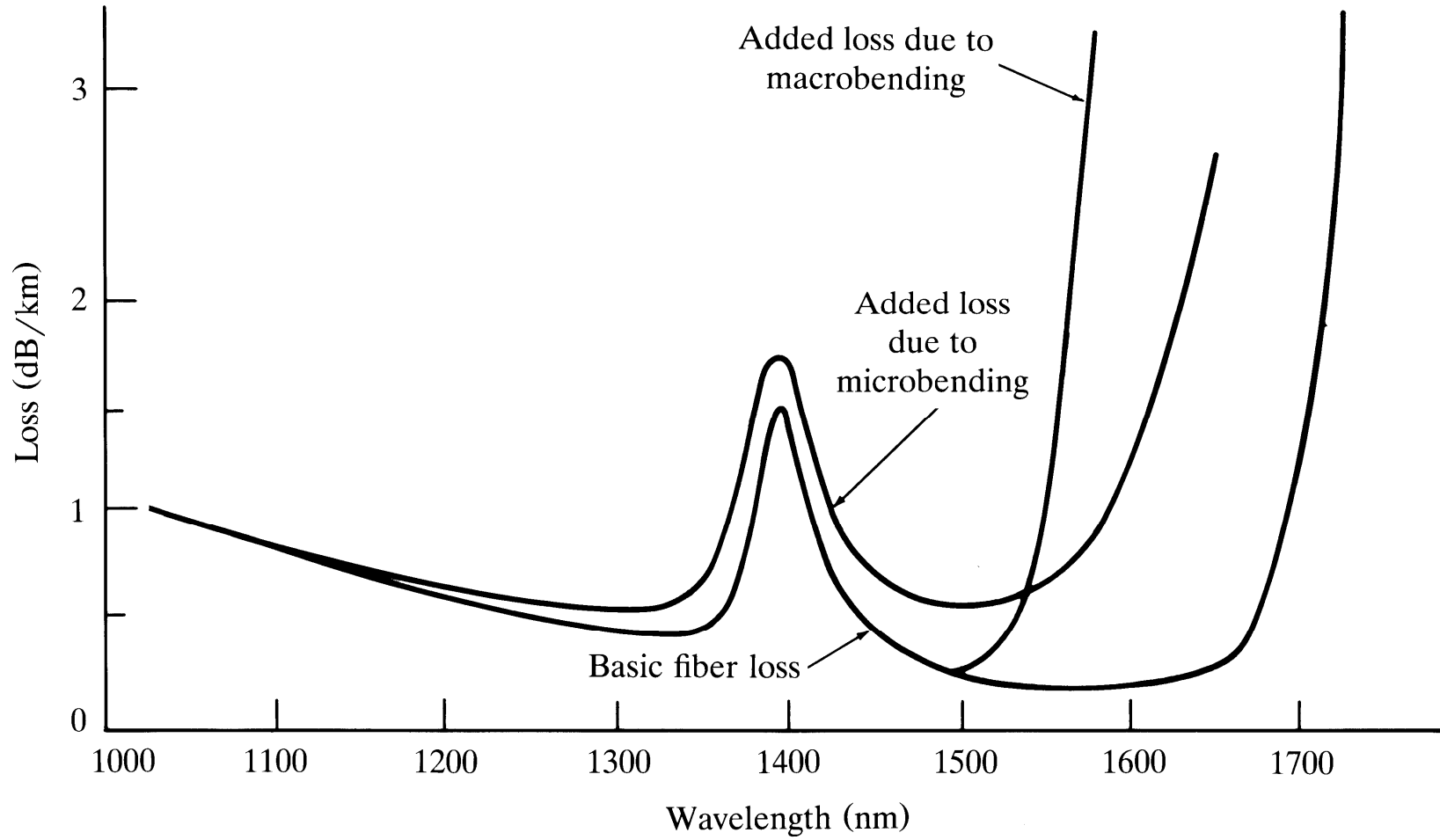

# Bending effects on loss vs MFD

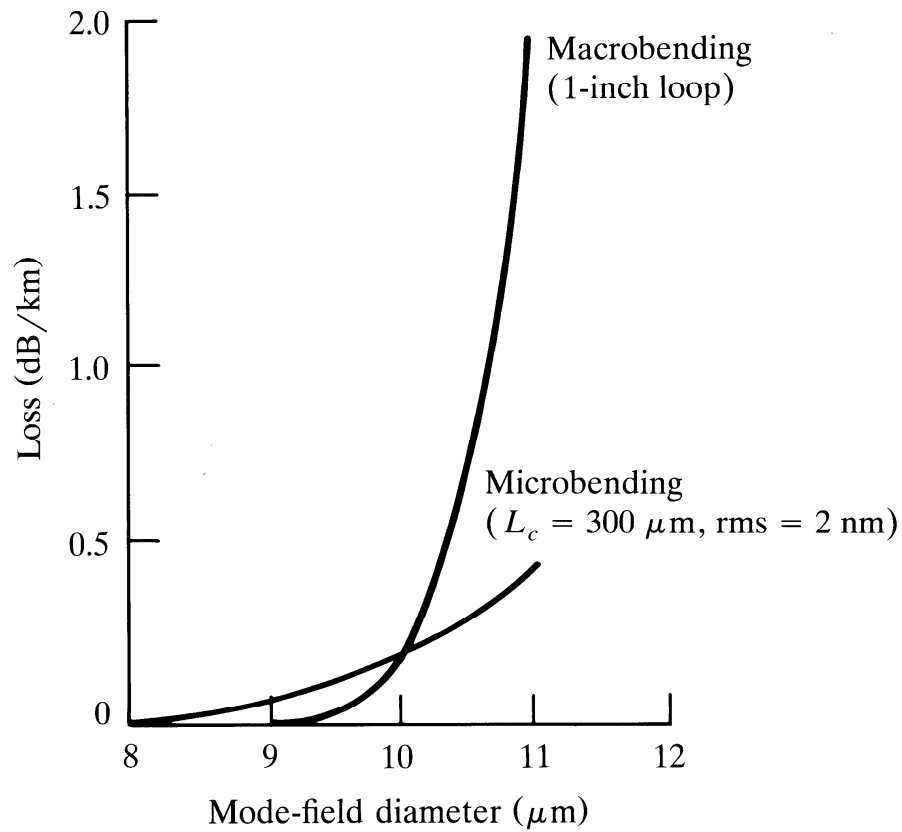

(a)

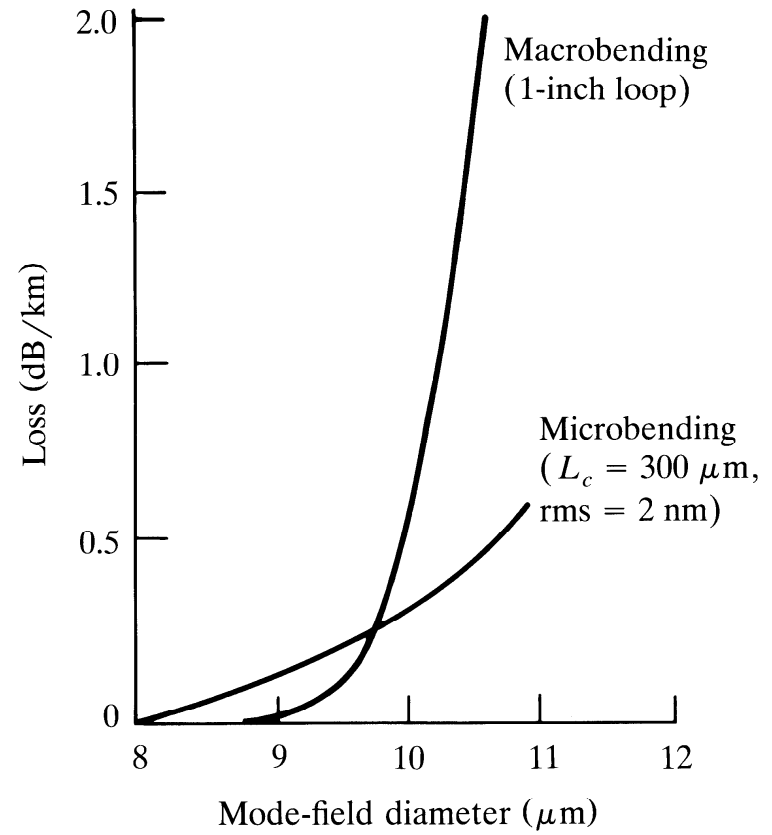

(b)

# Bend loss versus bend radius

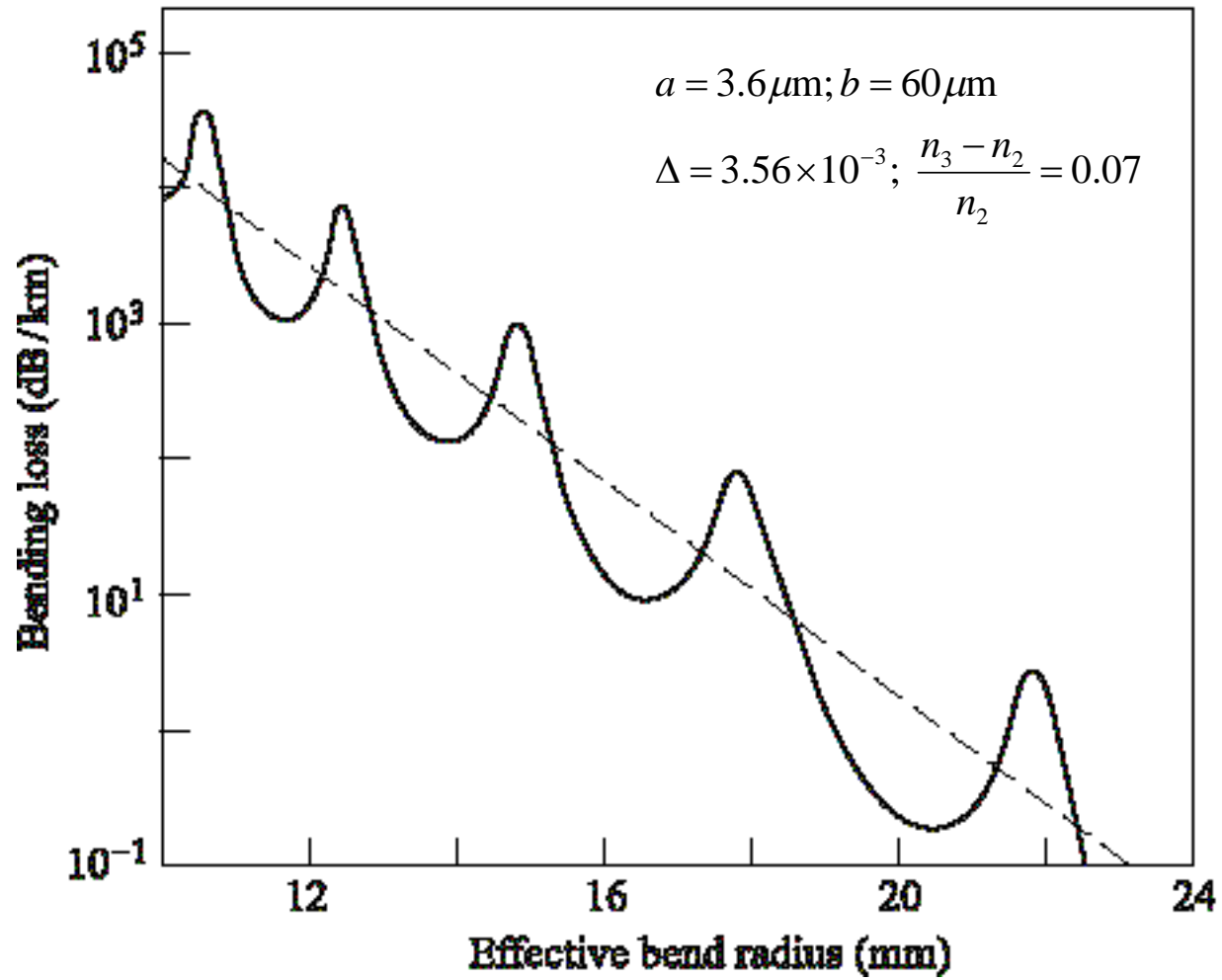

## **Unit-III**

# **FIBER OPTICAL SOURCES**

- Direct and indirect Band gap materials
- LED structures – Light source materials – Quantum efficiency and LED power, Modulation of a LED
- Laser Diodes – Modes and Threshold condition – Rate equations – External Quantum efficiency – Resonant frequencies – Laser Diodes structures and radiation patterns
- Single Mode lasers – Modulation of Laser Diodes, Temperature effects, Introduction to Quantum laser, Fiber amplifiers



# Direct and indirect Band gap materials

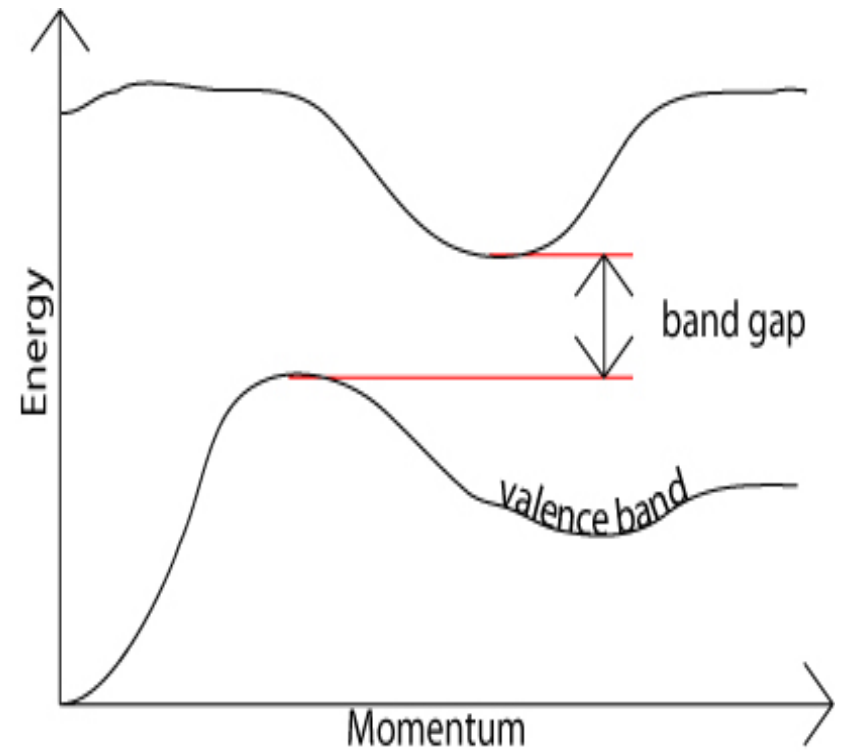
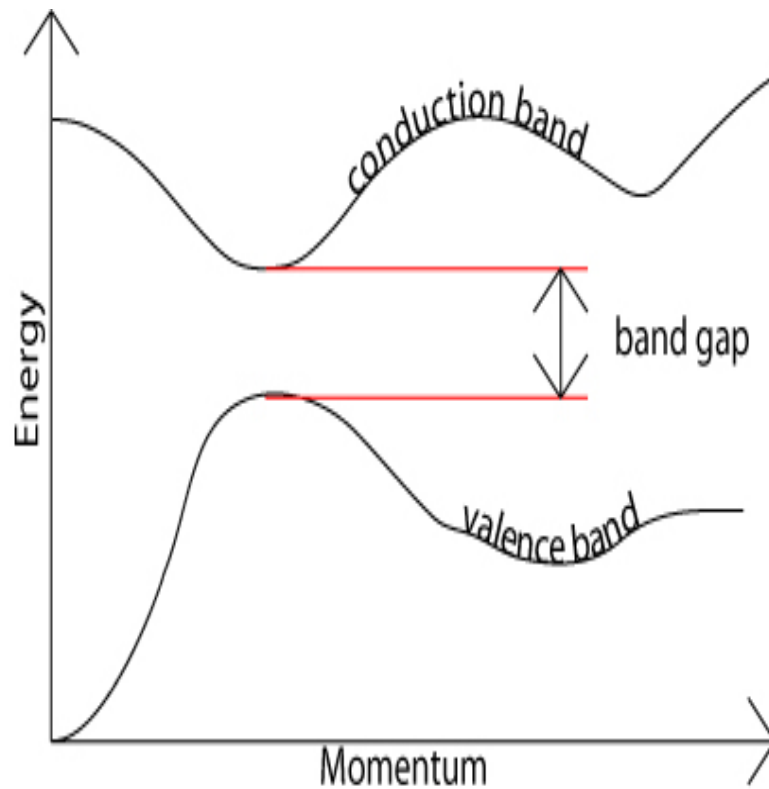

## Direct and indirect Band gap materials

- The band gap represents the minimum energy difference between the top of the valence band and the bottom of the conduction band.
- However, the top of the valence band and the bottom of the conduction band are not generally at the same value of the electron momentum.

## Direct and indirect Band gap materials

- In a direct band gap semiconductor, the top of the valence band and the bottom of the conduction band occur at the same value of momentum.
- In an indirect band gap semiconductor, the maximum energy of the valence band occurs at a different value of momentum to the minimum in the conduction band energy:

A **light-emitting diode** (LED) is a semiconductor device that emits incoherent light, through spontaneous emission, when a current is passed through it. Typically LEDs for the 850-nm region are fabricated using GaAs and AlGaAs. LEDs for the 1300-nm and 1550-nm regions are fabricated using InGaAsP and InP. The basic LED types used for fiber optic communication systems are the surface-emitting LED (SLED), the edge-emitting LED (ELED), and the superluminescent diode (SLD)

LED performance differences help link designers decide which device is appropriate for the intended application. For short-distance (0 to 3 km), low-data-rate fiber optic systems, SLEDs and ELEDs are the preferred optical source.

Typically, SLEDs operate efficiently for bit rates up to 250 megabits per second (Mb/s). Because SLEDs emit light over a wide area (wide far-field angle), they are almost exclusively used in multimode systems.

For medium-distance, medium-data-rate systems, ELEDs are preferred.

ELEDs may be modulated at rates up to 400 Mb/s.

ELEDs may be used for both single mode and multimode fiber systems. Both SLDs and ELEDs are used in long-distance, high-data-rate systems. SLDs are ELED-based diodes designed to operate in the superluminescence mode. A further discussion on superluminescence is provided later in this chapter. SLDs may be modulated at bit rates of over 400 Mb/s.

## Surface-Emitting LEDs

The surface-emitting LED (shown in figure 6-1) is also known as the Burrus LED in honor of C. A. Burrus, its developer. In SLEDs, the size of the primary active region is limited to a small circular area of 20  $\mu\text{m}$  to 50  $\mu\text{m}$  in diameter. The active region is the portion of the LED where photons are emitted. The primary active region is below the surface of the semiconductor substrate perpendicular to the axis of the fiber.

A **well** is etched into the substrate to allow [direct coupling](#) of the emitted light to the optical fiber. The etched well allows the optical fiber to come into close contact with the emitting surface. In addition, the epoxy resin that binds the optical fiber to the SLED reduces the refractive index mismatch, increasing coupling efficiency.



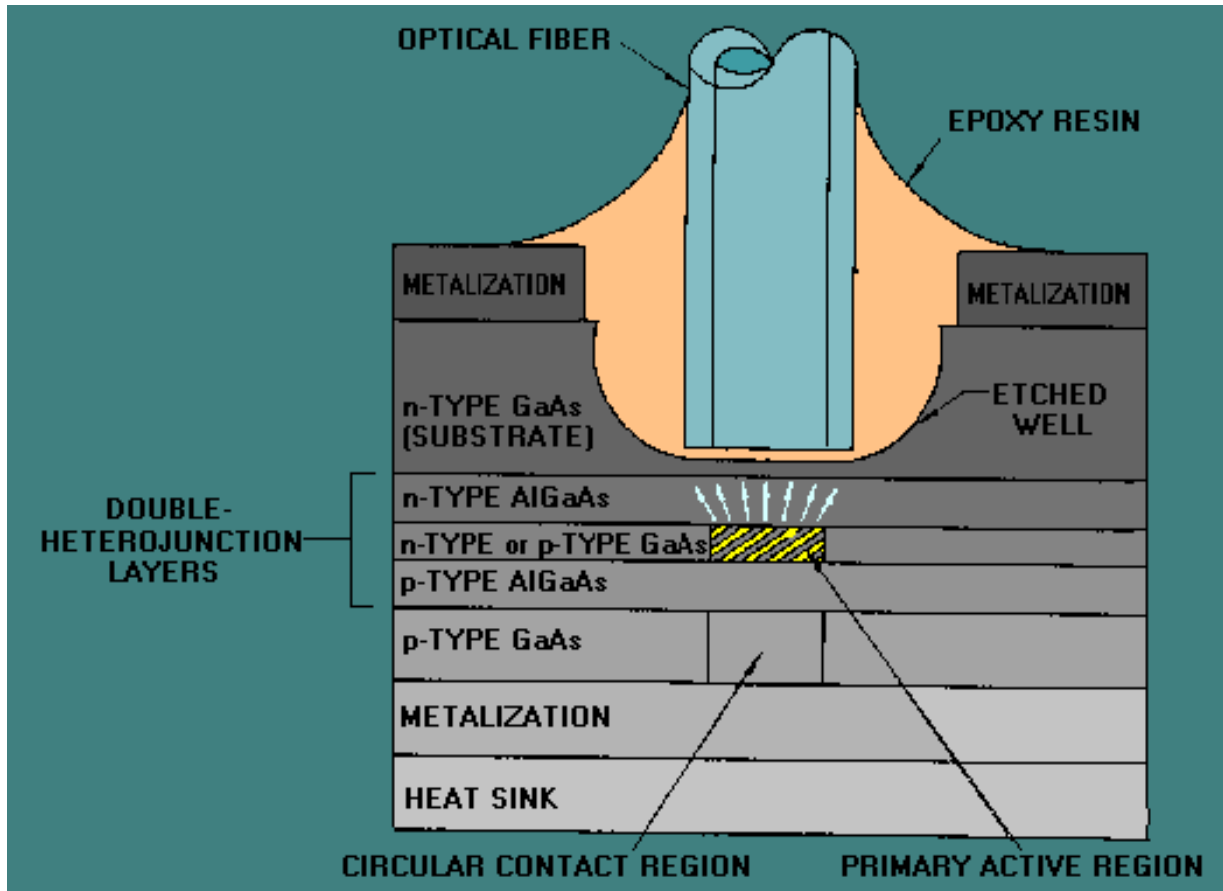

## Edge-Emitting LEDs

The demand for optical sources for longer distance, higher [bandwidth](#) systems operating at longer [wavelengths](#) led to the development of edge-emitting

LEDs. Figure 6-2 shows a typical ELED structure. It shows the different layers of semiconductor material used in the ELED. The primary active region of the ELED is a narrow stripe, which lies below the surface of the semiconductor substrate. The semiconductor substrate is cut or polished so that the stripe runs between the front and back of the device. The polished or cut surfaces at each end of the stripe are called facets.

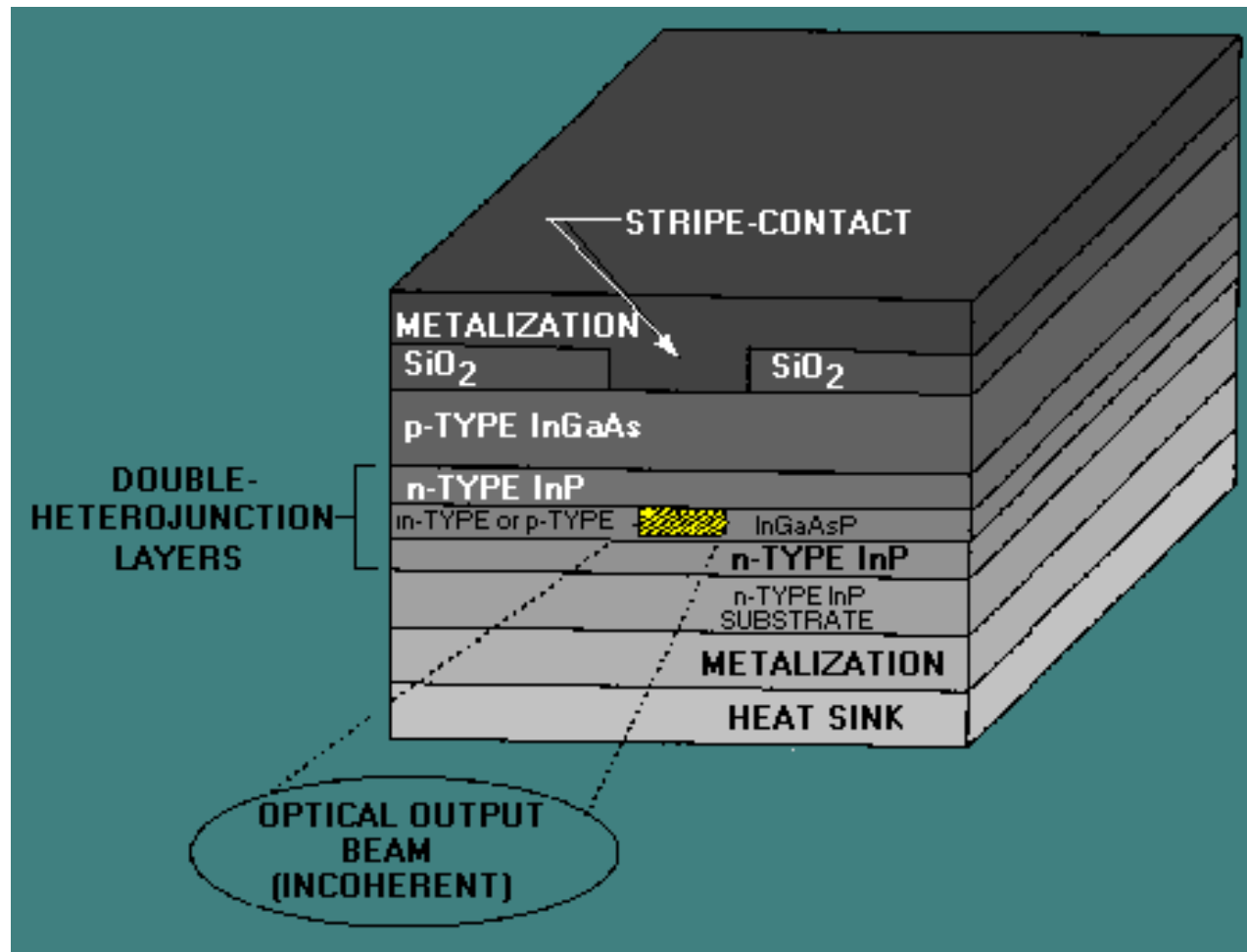

In an ELED the rear facet is highly reflective and the front facet is antireflection-coated. The rear facet reflects the light propagating toward the rear end-face back toward the front facet. By coating the front facet with antireflection material, the front facet reduces optical feedback and allows light emission. ELEDs emit light only through the front facet. ELEDs emit light in a narrow emission angle allowing for better source-to-fiber coupling. They couple more power into small NA fibers than SLEDs. ELEDs can couple enough power into single mode fibers for some applications. ELEDs emit power over a narrower spectral range than SLEDs. However, ELEDs typically are more sensitive to temperature fluctuations than SLEDs.

In an ELED the rear facet is highly reflective and the front facet is antireflection-coated. The rear facet reflects the light propagating toward the rear end-face back toward the front facet. By coating the front facet with antireflection material, the front facet reduces optical feedback and allows light emission. ELEDs emit light only through the front facet. ELEDs emit light in a narrow emission angle allowing for better source-to-fiber coupling. They couple more power into small NA fibers than SLEDs. ELEDs can couple enough power into single mode fibers for some applications. ELEDs emit power over a narrower spectral range than SLEDs. However, ELEDs typically are more sensitive to temperature fluctuations than SLEDs.

# Rate equations, Quantum Efficiency & Power of LEDs

- When there is no external carrier injection, the excess density decays exponentially due to electron-hole recombination.

$$n(t) = n_0 e^{-t/\tau} \quad [4-4]$$

- $n$  is the excess carrier density,

$n_0$  : initial injected excess electron density

$\tau$  : carrier lifetime.

- Bulk recombination rate  $R$ :

$$R = -\frac{dn}{dt} = \frac{n}{\tau} \quad [4-5]$$

- Bulk recombination rate ( $R$ )=Radiative recombination rate + nonradiative recombination rate

bulk recombination rate ( $R = 1/\tau$ ) =

radiative recombination rate ( $R_r = 1/\tau_r$ ) + nonradiative recombination rate ( $R_{nr} = 1/\tau_{nr}$ )

With an external supplied current density of  $J$  the rate equation for the electron-hole recombination is:

$$\frac{dn(t)}{dt} = \frac{J}{qd} - \frac{n}{\tau} \quad [4-6]$$

$q$  : charge of the electron;  $d$  : thickness of recombination region

In equilibrium condition:  $dn/dt=0$

$$n = \frac{J\tau}{qd} \quad [4-7]$$

## Internal Quantum Efficiency & Optical Power

$$\eta_{\text{int}} = \frac{R_r}{R_r + R_{nr}} = \frac{\tau_{nr}}{\tau_r + \tau_{nr}} = \frac{\tau}{\tau_r} \quad [4-8]$$

$\eta_{\text{int}}$  : internal quantum efficiency in the active region

Optical power generated internally in the active region in the LED is:

$$P_{\text{int}} = \eta_{\text{int}} \frac{I}{q} h\nu = \eta_{\text{int}} \frac{hcI}{q\lambda} \quad [4-9]$$

$P_{\text{int}}$  : Internal optical power,

$I$  : Injected current to active region



# External Quantum Efficiency

$$\eta_{\text{ext}} = \frac{\text{\# of photons emitted from LED}}{\text{\# of LED internally generated photons}} \quad [4-10]$$

- In order to calculate the external quantum efficiency, we need to consider the reflection effects at the surface of the LED. If we consider the LED structure as a simple 2D slab waveguide, only light falling within a cone defined by critical angle will be emitted from an LED.

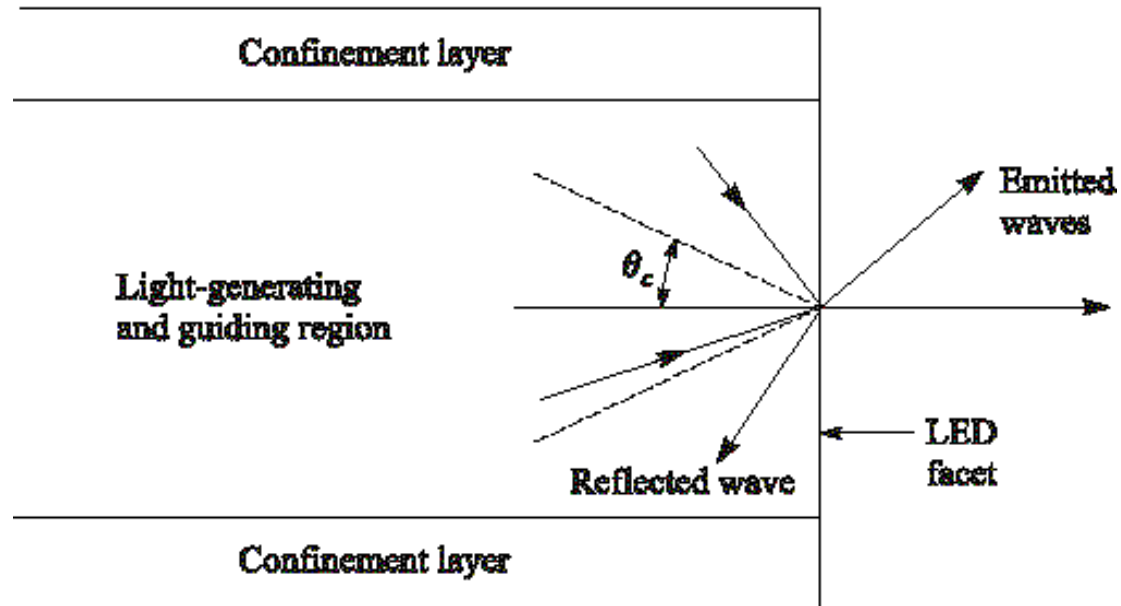

$$\eta_{\text{ext}} = \frac{1}{4\pi} \int_0^{\phi_c} T(\phi) (2\pi \sin \phi) d\phi \quad [4-11]$$

$$T(\phi) : \text{Fresnel Transmission Coefficient} \approx T(0) = \frac{4n_1 n_2}{(n_1 + n_2)^2} \quad [4-12]$$

$$\text{If } n_2 = 1 \Rightarrow \eta_{\text{ext}} \approx \frac{1}{n_1 (n_1 + 1)^2} \quad [4-13]$$

$$\text{LED emitted optical powr, } P = \eta_{\text{ext}} P_{\text{int}} \approx \frac{P_{\text{int}}}{n_1 (n_1 + 1)^2} \quad [4-14]$$

# Modulation of LED

- The frequency response of an LED depends on:
  - 1- Doping level in the active region
  - 2- Injected carrier lifetime in the recombination region,  $\tau_i$
  - 3- Parasitic capacitance of the LED
- If the drive current of an LED is modulated at a frequency of  $\omega$  the output optical power of the device will vary as:

$$P(\omega) = \frac{P_0}{\sqrt{1 + (\omega\tau_i)^2}} \quad [4-15]$$

- Electrical current is directly proportional to the optical power, thus we can define electrical bandwidth and optical bandwidth, separately.

$$\text{Electrical BW} = 10 \log \left[ \frac{p(\omega)}{p(0)} \right] = 20 \log \left[ \frac{I(\omega)}{I(0)} \right] \quad [4-16]$$

$p$  : electrical power,  $I$  : electrical current

$$\text{Optical BW} = 10 \log \left[ \frac{P(\omega)}{P(0)} \right] = 10 \log \left[ \frac{I(\omega)}{I(0)} \right]$$

[4-17]

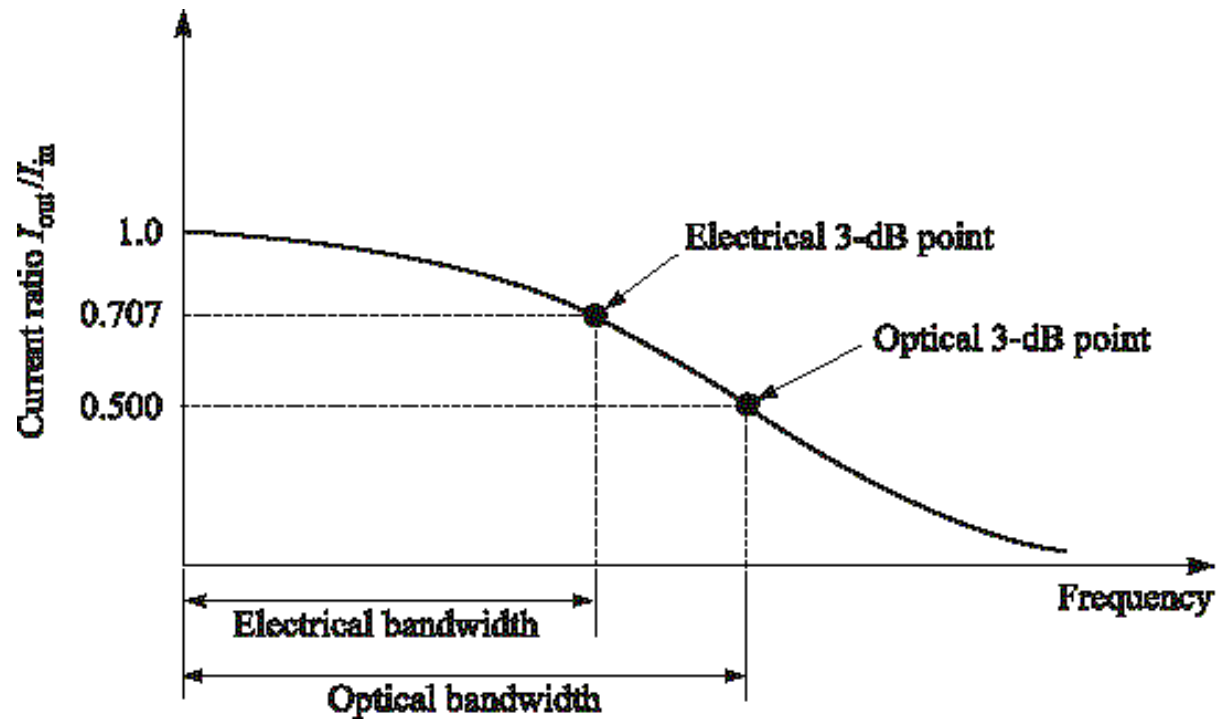

The [laser diode light](#) contains only a single frequency. Therefore, it can be focused by even a simple lens system to an extremely small point. There is no chromatic aberration since only one wavelength exists, also all of the energy from the light source is concentrated into a very small spot of light. LASER is an acronym for Light Amplification by the Stimulated Emission of Radiation.

## Laser Diode Construction

The above figure shows a simplified construction of a laser diode, which is similar to a [light emitting diode \(LED\)](#). It uses gallium arsenide doped with elements such as selenium, aluminium, or silicon to produce P type and N type [semiconductor materials](#). While a laser diode has an additional active layer of undoped (intrinsic) gallium arsenide have the thickness only a few nanometers, sandwiched between the P and N layers, effectively creating a [PIN diode \(P type-Intrinsic-N type\)](#). It is in this layer that the laser light is produced.

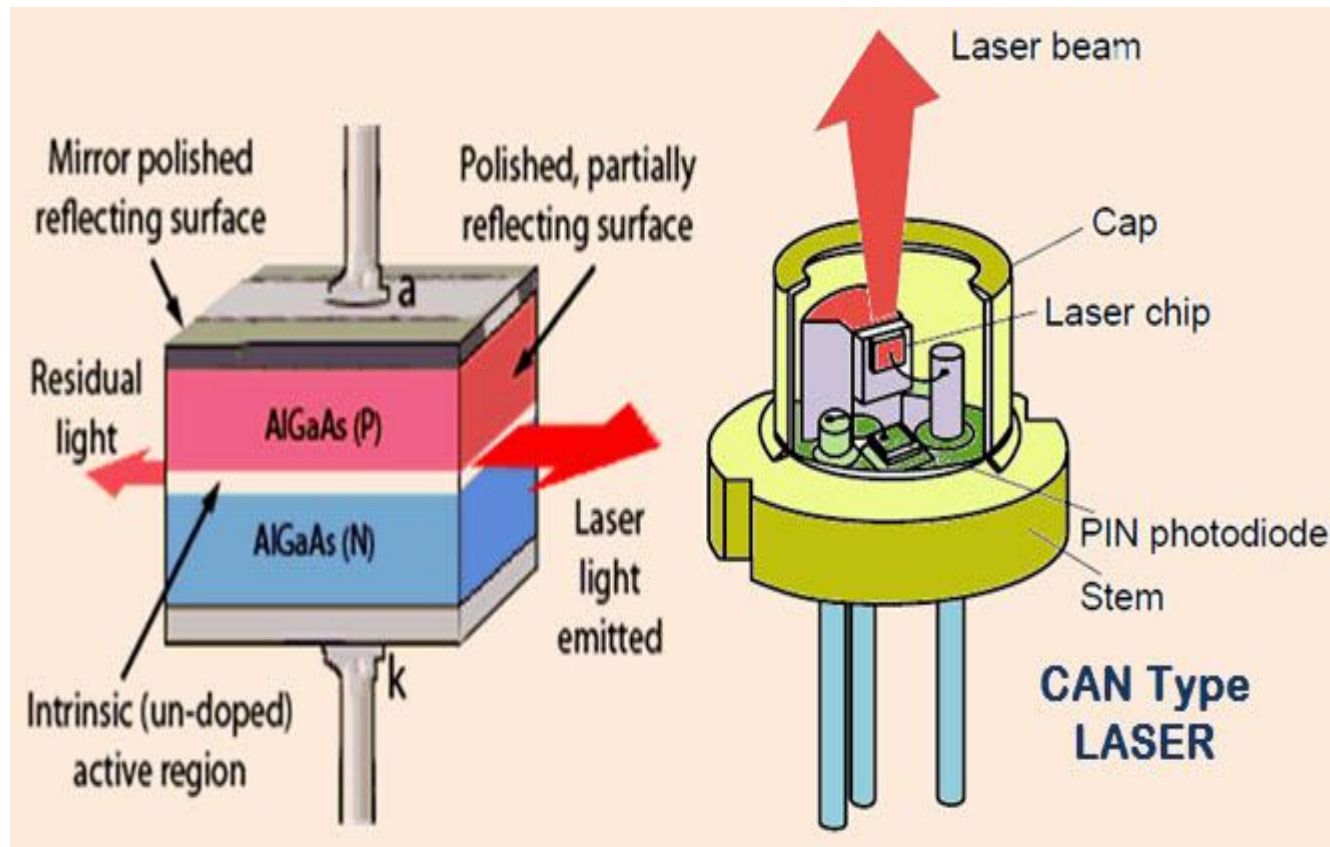

## **How Laser Diode Work?**

Every atom according to the quantum theory, can energies only within a certain discrete energy level. Normally, the atoms are in the lowest energy state or ground state. When an energy source given to the atoms in the ground state can be excited to go to one of the higher levels. This process is called absorption. After staying at that level for a very short duration, the atom returns to its initial ground state, emitting a photon in the process, This process is called spontaneous emission. These two processes, absorption and spontaneous emission, take place in a conventional light source.



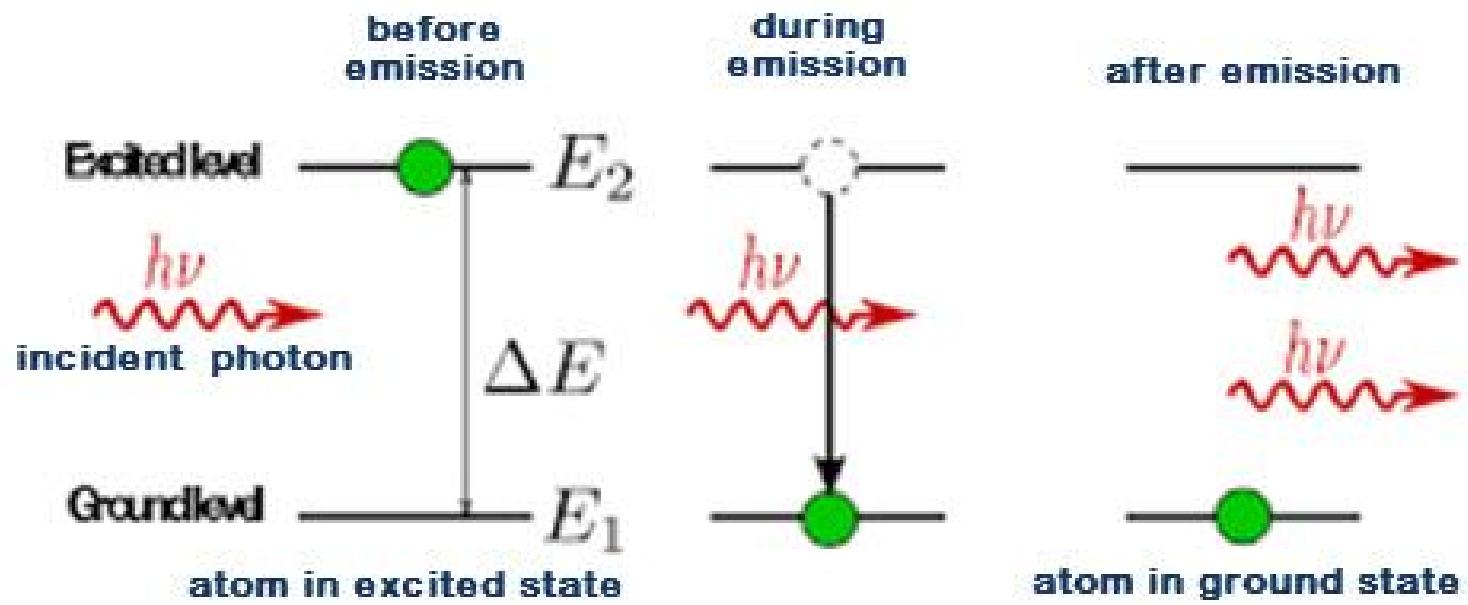

$$E_2 - E_1 = \Delta E = h\nu$$

## **Amplification and Population Inversion**

When favourable conditions are created for the stimulated emission, more and more atoms are forced to emit photons thereby initiating a chain reaction and releasing an enormous amount of energy. This results in a rapid build up of energy of emitting one particular wavelength (monochromatic light), travelling coherently in a particular, fixed direction. This process is called amplification by stimulated emission.

The number of atoms in any level at a given time is called the population of that level. Normally, when the material is not excited externally, the population of the lower level or ground state is greater than that of the upper level. When the population of the upper level exceeds that of the lower level, which is a reversal of the normal occupancy, the process is called population inversion.

## Main laser diode types

Some of the main types of laser diode include the following types:

***Double heterostructure laser diode*** : The double heterojunction laser diode is made up by sandwiching a layer of a low bandgap material with a layer on either side of high bandgap layers. This makes the two heterojunctions as the materials themselves are different and not just the same material with different types of doping. Common materials for the double heterojunction laser diode are Gallium Arsenide, GaAs, and aluminium gallium arsenide, AlGaAs.

The advantage of the double heterojunction laser diode over other types is that the holes and electrons are confined to the thin middle layer which acts as the active region. By containing the electrons and holes within this area more effectively, more electron-hole pairs are available for the laser optical amplification process. Additionally the change in material at the heterojunction helps contain the light within the active region providing additional benefit.

*Quantum well laser diode:* The quantum well laser diode uses a very thin middle layer - this acts as a quantum well where the vertical component of the electron wave function is quantised. As the quantum well has an abrupt edge, this concentrates electrons in energy states that contribute to laser action, and this increases the efficiency of the system.

In addition to the single quantum well laser diodes, multiple quantum well laser diodes also exist. The presence of multiple quantum wells improves the overlap between the gain region and the optical waveguide mode.

## BASIC OPERATION OF OPTICAL AMPLIFIER.

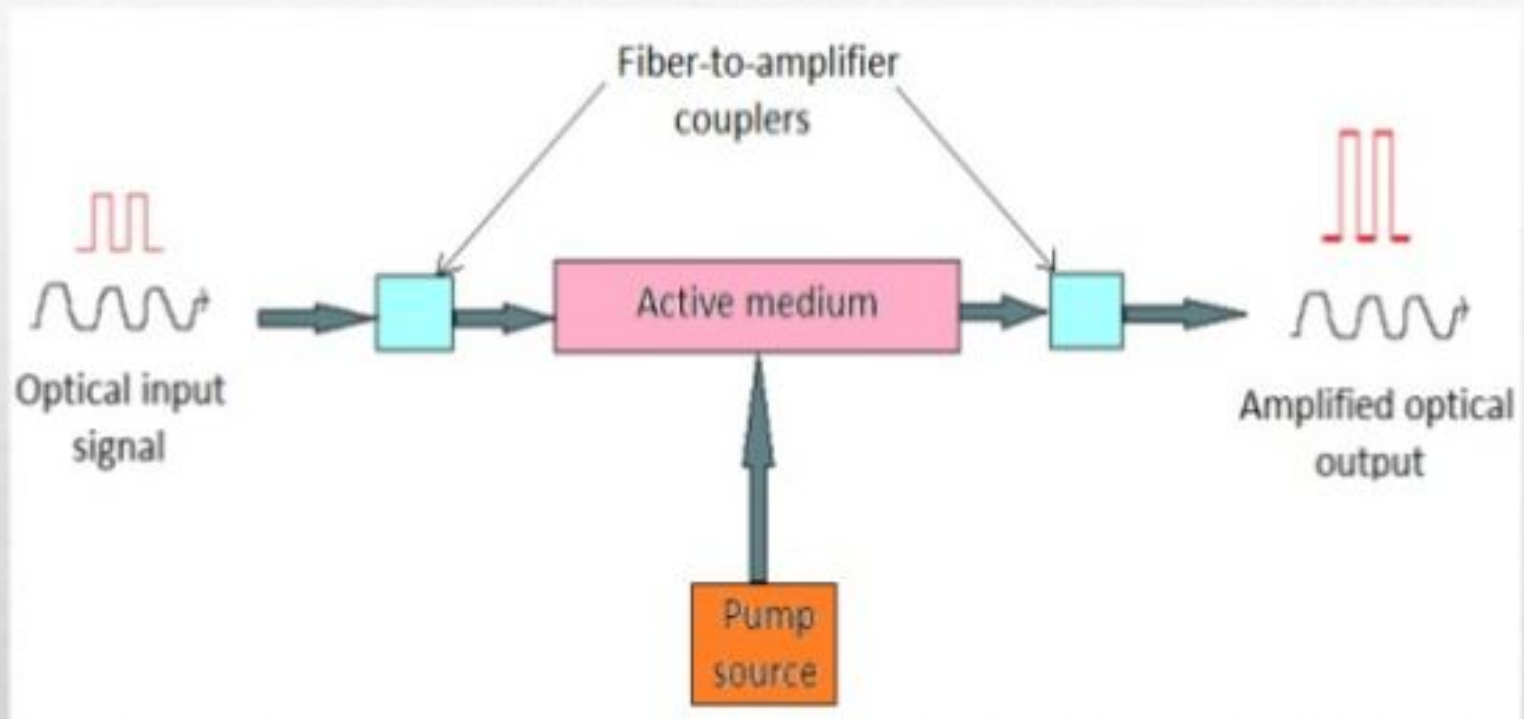

## Unit-IV

# FIBER OPTICAL RECEIVERS

- PIN and APD diodes
- Photo detector noise, SNR, Detector Response time
- Avalanche multiplication Noise – Comparison of Photo detectors
- Fundamental Receiver Operation – pre-amplifiers
- Error Sources – Receiver Configuration – Probability of Error – The Quantum Limit



## *PIN* Photodetector

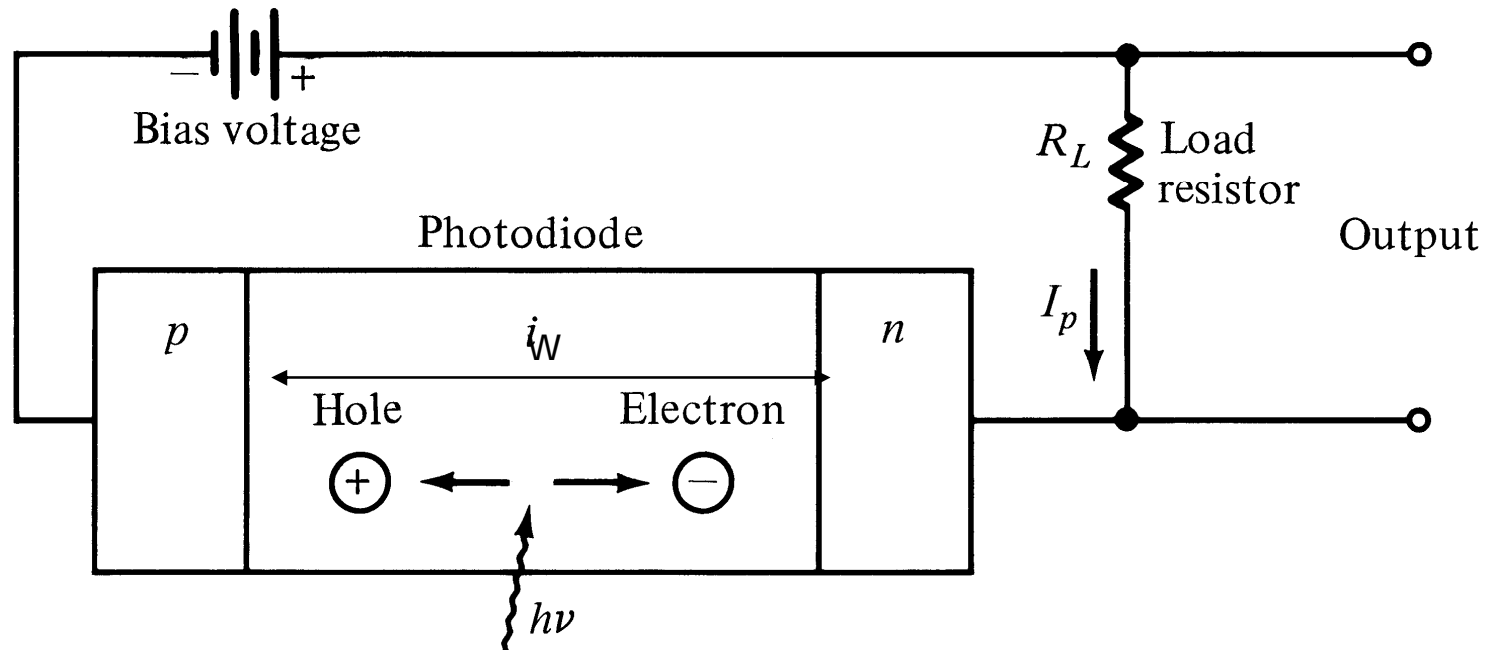

The high electric field <sup>Photon</sup> present in the depletion region causes photo-generated carriers to separate and be collected across the reverse –biased junction. This give rise to a current Flow in an external circuit, known as **photocurrent**.

# Energy-Band diagram for a *pin* photodiode

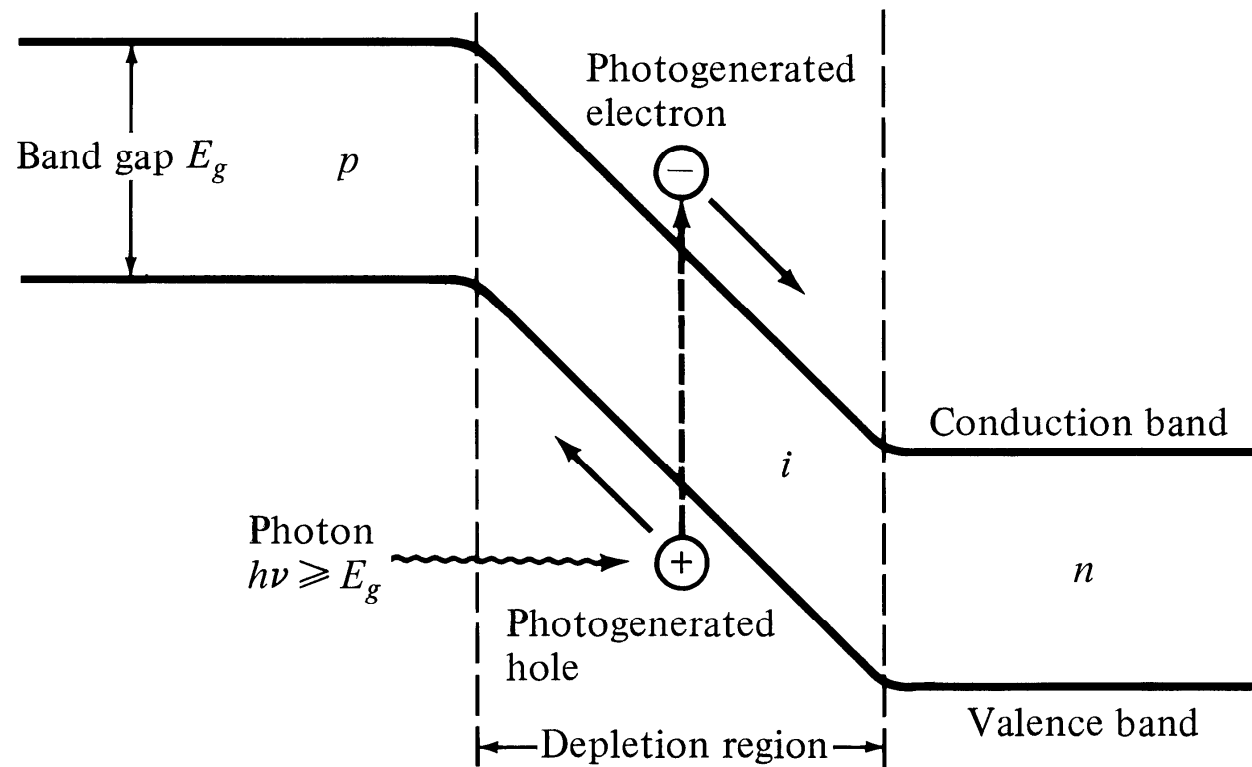

## Photocurrent

- Optical power absorbed,  $P(x)$  in the depletion region can be written in terms of incident optical power,  $P_0$  :

$$P(x) = P_0 (1 - e^{-\alpha_s(\lambda)x}) \quad [6-1]$$

- Absorption coefficient  $\alpha_s(\lambda)$  strongly depends on wavelength. The upper wavelength cutoff for any semiconductor can be determined by its energy gap as follows:

$$\lambda_c (\mu\text{m}) = \frac{1.24}{E_g (\text{eV})} \quad [6-2]$$

- Taking entrance face reflectivity into consideration, the absorbed power in the width of depletion region,  $w$ , becomes:  $(1 - R_f)P(w) = P_0(1 - e^{-\alpha_s(\lambda)w})(1 - R_f)$

# Optical Absorption Coefficient

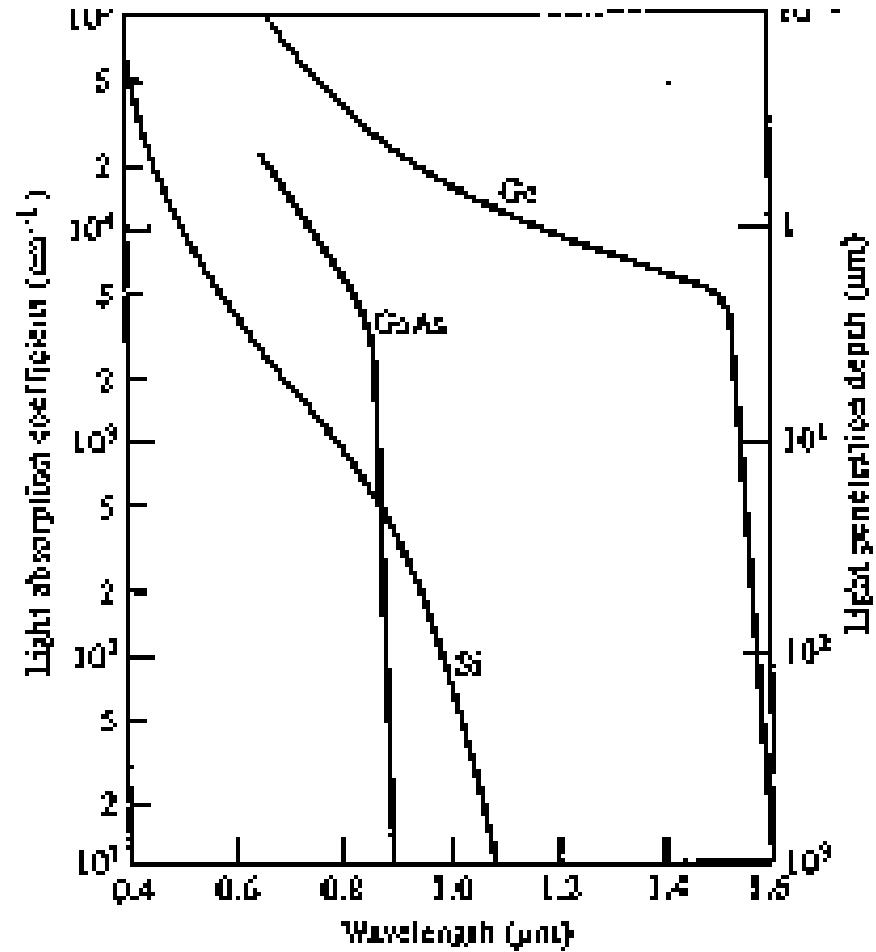

# Responsivity

- The primary photocurrent resulting from absorption is:

$$I_p = \frac{q}{h\nu} P_0 (1 - e^{-\alpha_s(\lambda)w}) (1 - R_f)$$

[6-3]

- Quantum Efficiency:

$$\eta = \frac{\text{\# of electron - hole photogenerated pairs}}{\text{\# of incident photons}}$$

$$\eta = \frac{I_p / q}{P_0 / h\nu}$$

[6-4]

- Responsivity:

$$\mathfrak{R} = \frac{I_p}{P_0} = \frac{\eta q}{h\nu} \quad [\text{A/W}]$$

[6-5]

# Responsivity vs. wavelength

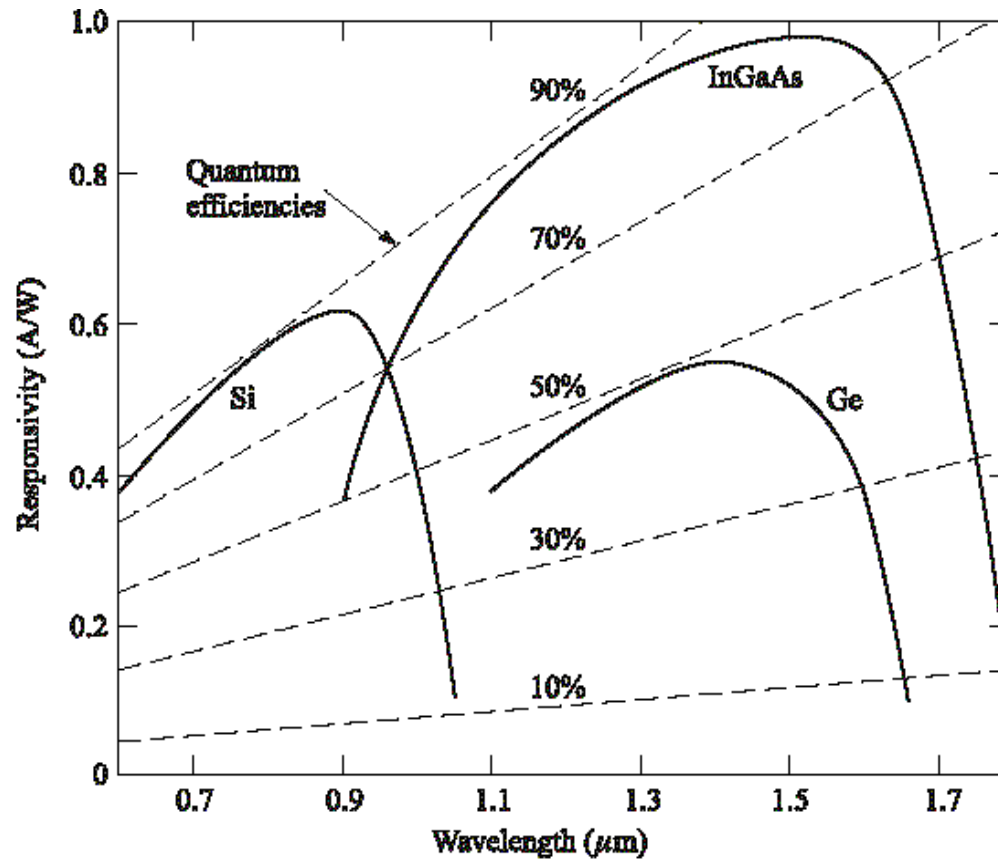

# Avalanche Photodiode (APD)

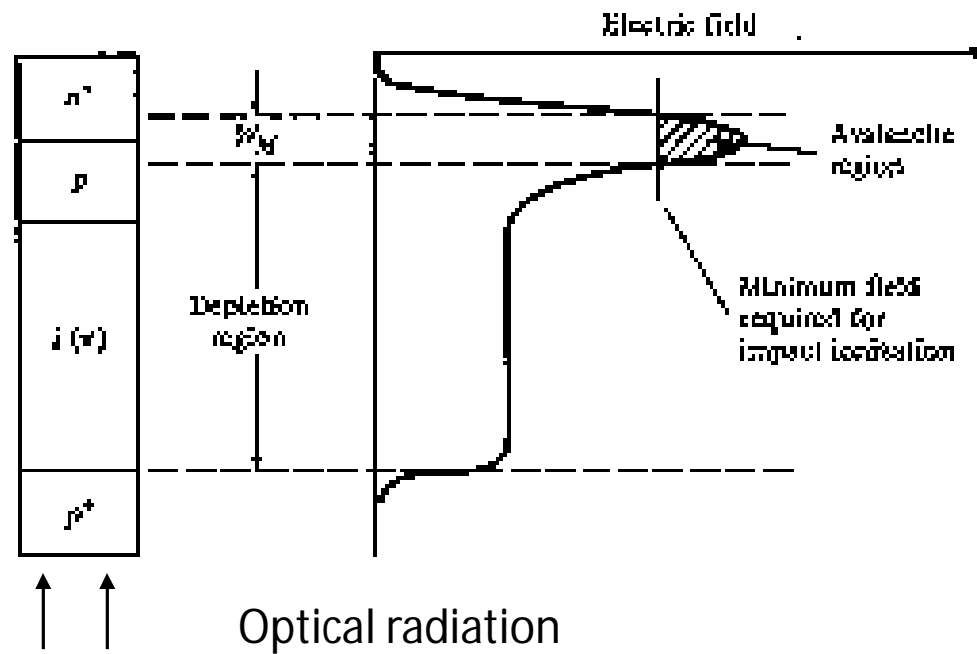

Reach-Through APD structure (RAPD) showing the electric fields in depletion region and multiplication region.

APDs internally multiply the primary photocurrent before it enters to following circuitry.

In order to carrier multiplication take place, the photogenerated carriers must traverse along a high field region. In this region, photogenerated electrons and holes gain enough energy to ionize bound electrons in VB upon colliding with them. This multiplication is known as **impact ionization**. The newly created carriers in the presence of high electric field result in more ionization called **avalanche effect**.



## Responsivity of APD

- The multiplication factor (current gain)  $M$  for all carriers generated in the photodiode is defined as:

$$M = \frac{I_M}{I_p} \quad [6-6]$$

- Where  $I_M$  is the average value of the total multiplied output current &  $I_p$  is the primary photocurrent.

$$\mathfrak{R}_{APD} = \frac{\eta q}{h \nu} M = \mathfrak{R}_0 M \quad [6-7]$$

- The responsivity of APD can be calculated by considering the current gain as:

# Current gain ( $M$ ) vs. Voltage for different optical wavelengths

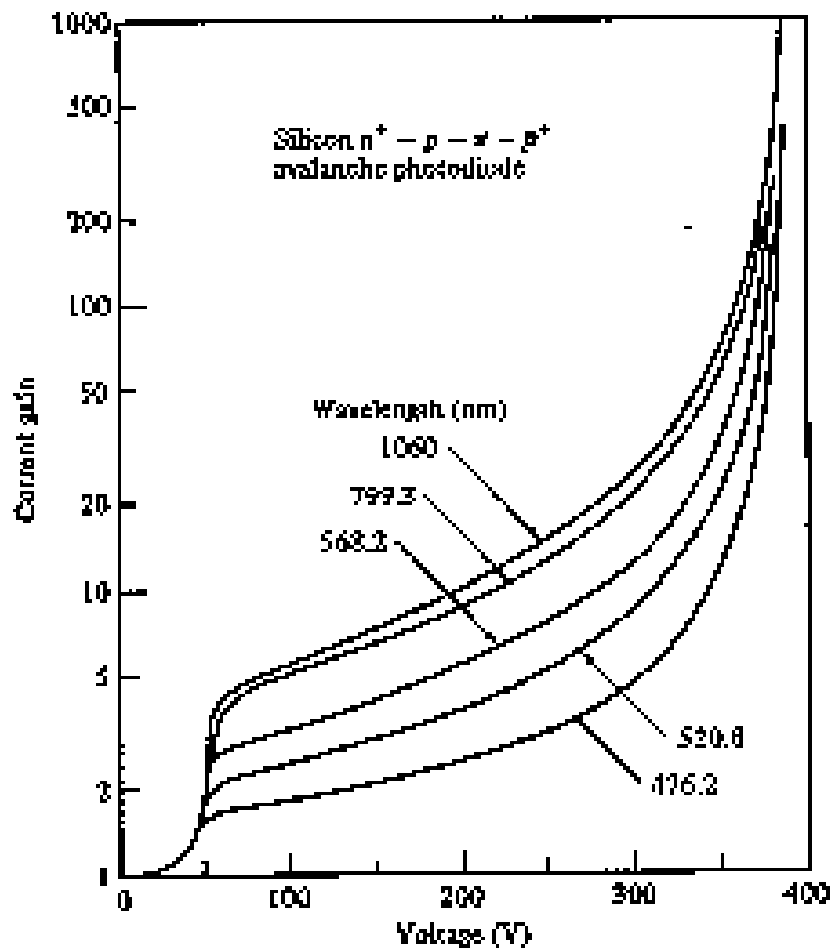

## Photodetector Noise & S/N

- Detection of weak optical signal requires that the photodetector and its following amplification circuitry be optimized for a desired signal-to-noise ratio.
- It is the noise current which determines the minimum optical power level that can be detected. This minimum detectable optical power defines the **sensitivity** of photodetector. That is the optical power that generates a photocurrent with the amplitude equal to that of the total noise current ( $S/N=1$ )

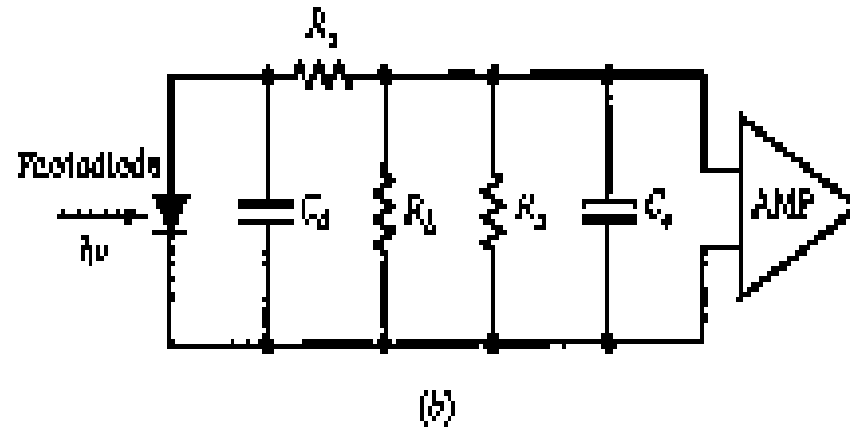
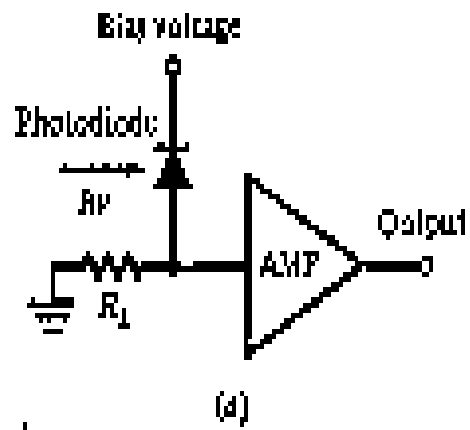

✓

$$\frac{S}{N} = \frac{\text{signal power from photocurrent}}{\text{photodiode noise power} + \text{amplifier noise power}}$$

## Signal Calculation

- Consider the modulated optical power signal  $P(t)$  falls on the photodetector with the form of:

$$P(t) = P_0 [1 + ms(t)] \quad [6-8]$$

- Where  $s(t)$  is message electrical signal and  $m$  is modulation index. Therefore the primary photocurrent is (for pin photodiode  $M=1$ ):

$$i_{\text{ph}} = \frac{\eta q}{h\nu} MP(t) = I_P [\text{DC value}] + i_p(t) [\text{AC current}] \quad [6-9]$$

- The root mean square signal current is then:

$$\langle i_s^2 \rangle = \langle i_p^2 \rangle M^2 = \sigma_s^2 \quad [6-9]$$

$$\langle i_p^2 \rangle = \sigma_p^2 = \frac{m^2 I_P^2}{2} \quad \text{for sinusoidal signal} \quad [6-10]$$

## Noise Sources in Photodetectors

- The principal noises associated with photodetectors are :
  - 1- Quantum (Shot) noise:** arises from statistical nature of the production and collection of photo-generated electrons upon optical illumination. It has been shown that the statistics follow a Poisson process.
  - 2- Dark current noise:** is the current that continues to flow through the bias circuit in the absence of the light. This is the combination of **bulk dark current**, which is due to thermally generated  $e$  and  $h$  in the  $pn$  junction, and the **surface dark current**, due to surface defects, bias voltage and surface area.

In order to calculate the total noise presented in photodetector, we should sum up the root mean square of each noise current by assuming that those are uncorrelated.

Total photodetector noise current = quantum noise current + bulk dark current noise + surface current noise

## Noise calculation (1)

- **Quantum noise current** (lower limit on the sensitivity):

$$\left\langle i_Q^2 \right\rangle = \sigma_Q^2 = 2qI_P B M^2 F(M) \quad [6-11]$$

- $B$ : Bandwidth,  $F(M)$  is the noise figure and generally is  $F(M) \approx M^x$   $0 \leq x \leq 1.0$
- **Bulk dark current noise:**

$$\left\langle i_{DB}^2 \right\rangle = \sigma_{DB}^2 = 2qI_D B M^2 F(M) \quad [6-12]$$

$I_D$  is bulk dark current

Note that for *pin* photodiode  
 $M^2 F(M) = 1$

- **Surface dark current noise:**  $I_L$  is the surface current.

$$\left\langle i_{DS}^2 \right\rangle = \sigma_{DS}^2 = 2qI_L B \quad [6-13]$$



## Noise calculation (2)

- The total rms photodetector noise current is:

$$\begin{aligned}\langle i_N^2 \rangle &= \sigma_N^2 = \langle i_Q^2 \rangle + \langle i_{DB}^2 \rangle + \langle i_{DS}^2 \rangle \\ &= 2q(I_P + I_D)BM^2F(M) + 2qI_LB\end{aligned}\quad [6-14]$$

- The thermal noise of amplifier connected to the photodetector is:

$$\langle i_T^2 \rangle = \sigma_T^2 = \frac{4k_BTB}{R_L}\quad [6-15]$$

$R_L$  input resistance of amplifier, and  $k_B = 1.38 \times 10^{-23} \text{ JK}^{-1}$  is Boltzmann cte.

## S/N Calculation

- Having obtained the signal and total noise, the signal-to-noise-ratio can be written as:

$$\frac{S}{N} = \frac{\langle i_P^2 \rangle M^2}{2q(I_P + I_D)BM^2 F(M) + 2qI_L B + 4k_B T B / R_L}$$

[6-16]

- Since the noise figure  $F(M)$  increases with  $M$ , there always exists an optimum value of  $M$  that maximizes the S/N. For sinusoidally modulated signal with  $m=1$  and  $F(M) \approx M^x$  :

$$M_{\text{opt}}^{x+2} = \frac{2qI_L + 4k_B T / R_L}{xq(I_P + I_D)}$$

[6-17]

## Photodetector Response Time

- The response time of a photodetector with its output circuit depends mainly on the following three factors:
  - 1- The transit time of the photocarriers in the depletion region. The transit time  $t_d$  depends on the carrier drift velocity  $v_d$  and the depletion layer width  $w$ , and is given by:

$$t_d = \frac{w}{v_d} \quad [6-18]$$

2- Diffusion time of photocarriers outside depletion region.

3-  $RC$  time constant of the circuit. The circuit after the photodetector acts like  $RC$  low pass filter with a passband given by:

$$B = \frac{1}{2\pi R_T C_T} \quad R_T = R_s \parallel R_L \quad \text{and} \quad C_T = C_a + C_d \quad [6-19]$$

# Photodiode response to optical pulse

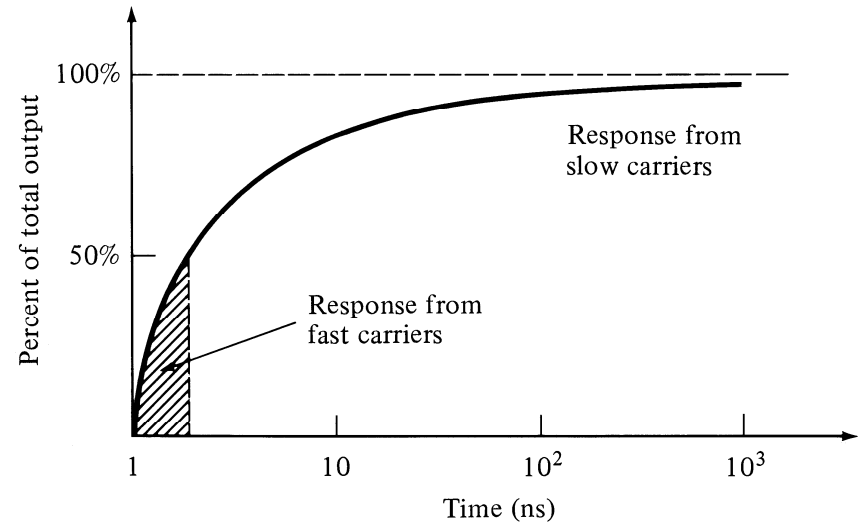
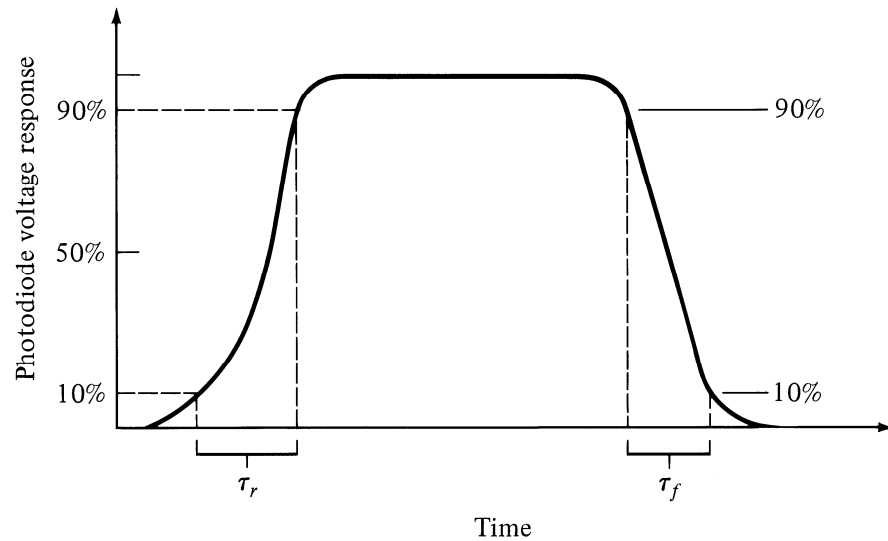

Typical response time of the photodiode that is not fully depleted

# Various optical responses of photodetectors: Trade-off between quantum efficiency & response time

- To achieve a high quantum efficiency, the depletion layer width must be larger than  $1/\alpha_s$  (the inverse of the absorption coefficient), so that most of the light will be absorbed. At the same time with large width, the capacitance is small and  $RC$  time constant getting smaller, leading to faster response, but wide width results in larger transit time in the depletion region. Therefore there is a trade-off between width and QE. It is shown that the best is:

$$1/\alpha_s \leq w \leq 2/\alpha_s$$

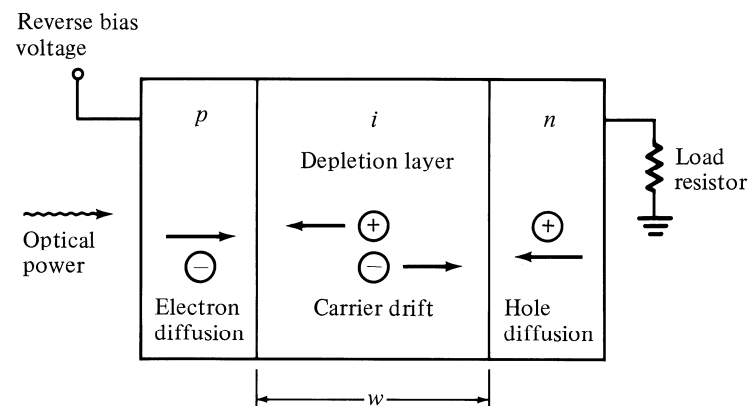
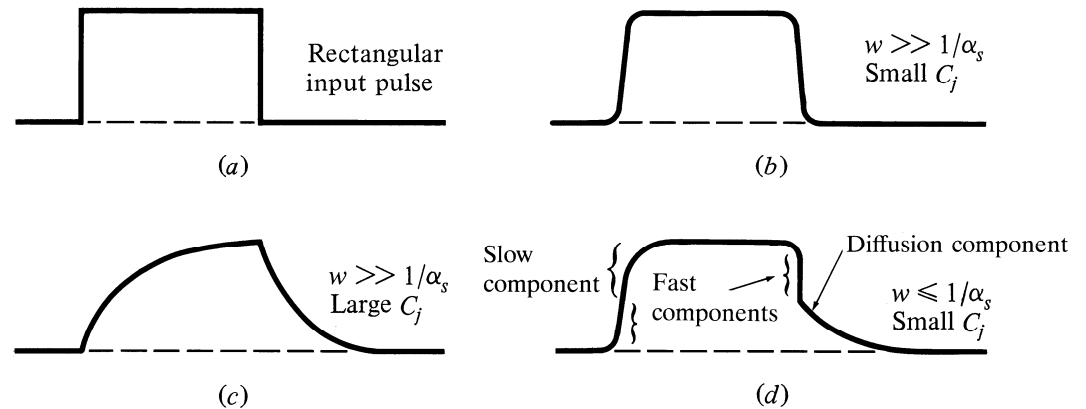

## Structures for InGaAs APDs

- Separate-absorption-and multiplication (SAM) APD

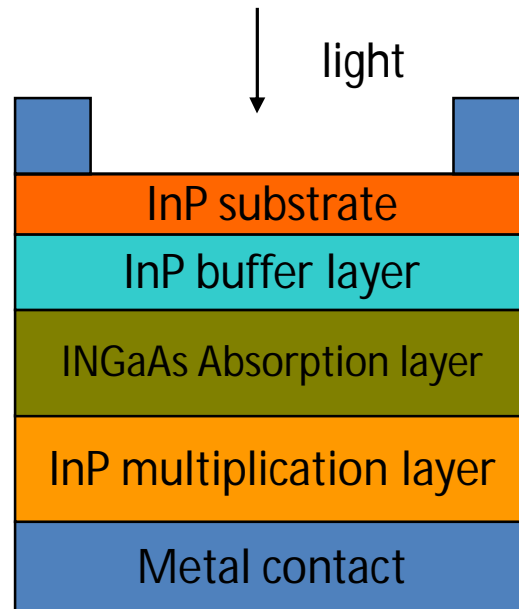

- InGaAs APD superlattice structure (The multiplication region is composed of several layers of InAlGaAs quantum wells separated by InAlAs barrier layers).

# Temperature effect on avalanche gain

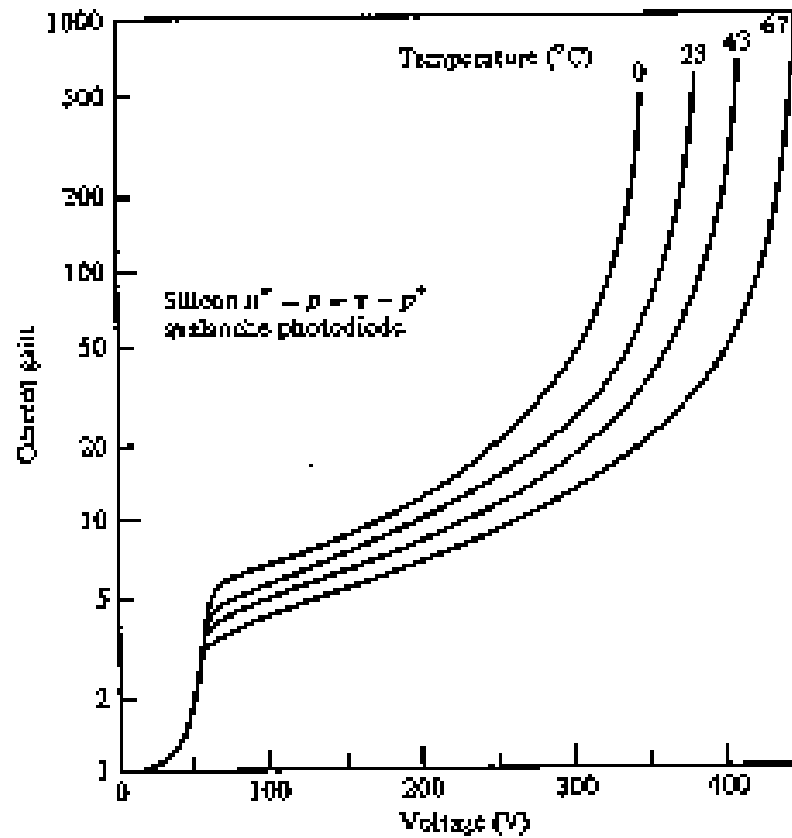



## Comparison of photodetectors

Parameter	Symbol	Unit	Si	Ge	InGaAs
Wavelength range	$\lambda$	nm	400-1100	800-1650	1100-1700
Responsivity	$\mathcal{R}$	A/W	0.4-0.6	0.4-0.5	0.75-0.95
Dark current	$I_D$	nA	1-10	50-500	0.5-2.0
Rise time	$\tau_r$	ns	0.5-1	0.1-0.5	0.05-0.5
Bandwidth	$B$	GHz	0.3-0.7	0.5-3	1-2
Bias voltage	$V_B$	V	5	5-10	5

**TABLE 6-2**  
**Generic operating parameters of Si, Ge, and InGaAs avalanche photodiodes**

Parameter	Symbol	Unit	Si	Ge	InGaAs
Wavelength range	$\lambda$	nm	400-1100	800-1650	1100-1700
Avalanche gain	$M$	—	20-400	50-200	10-40
Dark current	$I_D$	nA	0.1-1	50-500	10-50 @ $M = 10$
Rise time	$\tau_r$	ns	0.1-2	0.5-0.8	0.1-0.5
Gain · bandwidth	$M \cdot B$	GHz	100-400	2-10	20-250
Bias voltage	$V_B$	V	150-400	20-40	20-30

# Receiver Functional Block Diagram

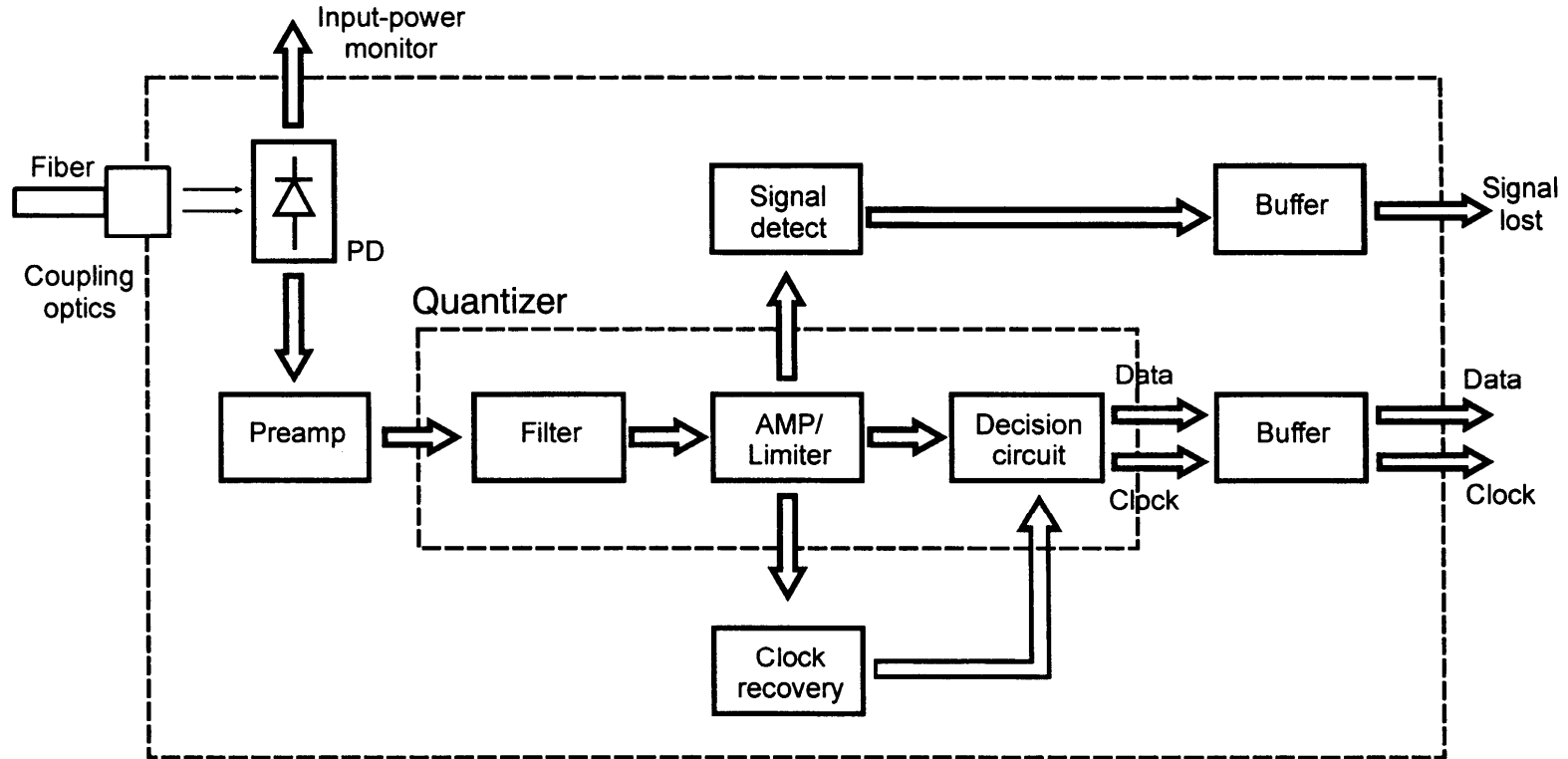

# Receiver Types

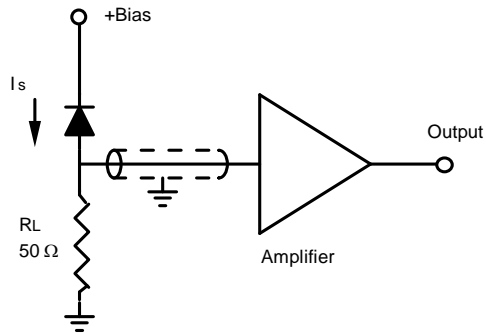

## Low Impedance

Low Sensitivity  
Easily Made  
Wide Band

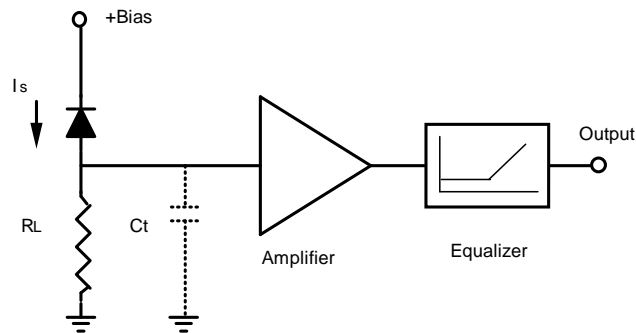

## High Impedance

Requires Equalizer for high BW  
High Sensitivity  
Low Dynamic Range  
Careful Equalizer Placement Required

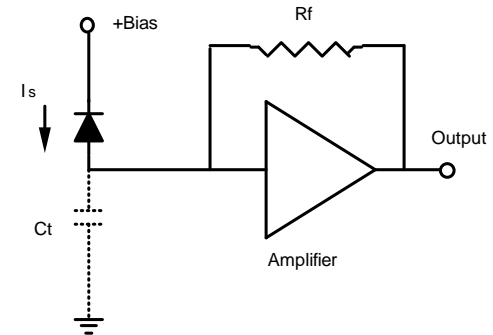

## Transimpedance

High Dynamic Range  
High Sensitivity  
Stability Problems  
Difficult to equalize

# Receiver Noise Sources

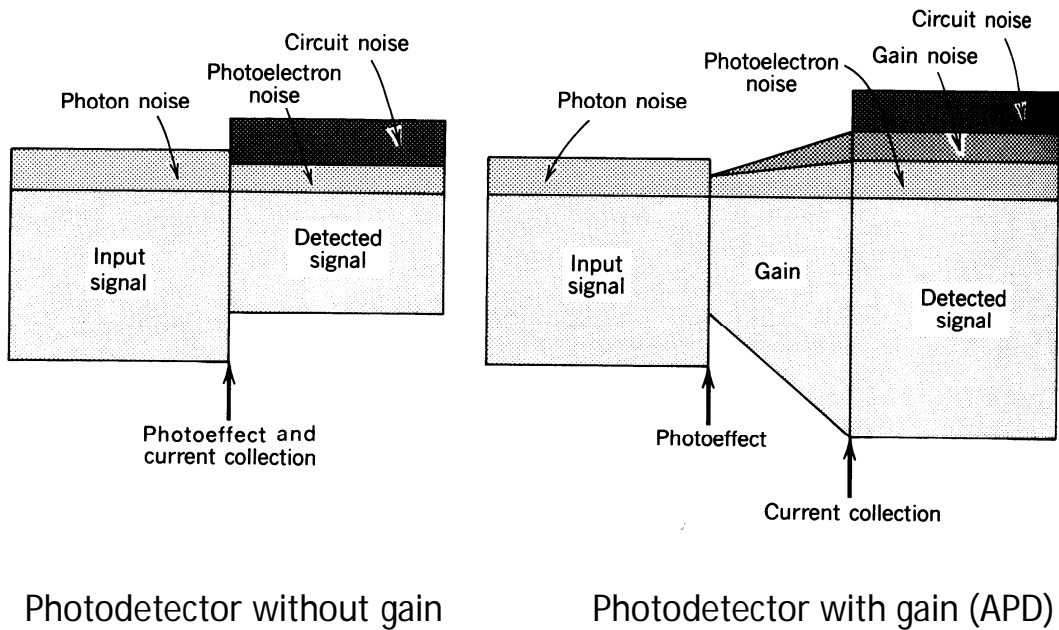

- Photon Noise  
Also called shot noise or Quantum noise, described by poisson statistics
- Photoelectron Noise  
Randomness of photodetection process leads to noise
- Gain Noise  
eg. gain process in APDs or EDFAs is noisy
- Receiver Circuit noise  
Resistors and transistors in the the electrical amplifier contribute to circuit noise

# Noise

**Johnson noise (Gaussian and white)**

$$\text{Noise Power} = 4kTB = \frac{\langle V_n \rangle^2}{R} = \langle i_n^2 \rangle R$$

$$i_{rms} = \sqrt{\frac{4kTB}{R}} \quad V_{rms} = \sqrt{4kTRB}$$

**Shot noise (Gaussian and white)**

$$\text{rms noise current} = \langle i_n^2 \rangle^{1/2} = (2qIB)^{1/2}$$

**"1/f" noise**

$$\text{spectral density} = \frac{K}{f} \quad \text{V}^2/\text{Hz}$$

for FETs

$$K = \frac{4kT\Gamma}{g_m} f_c$$

where  $f_c$  is the FET corner frequency and  $\Gamma$  is the channel noise factor



Frequency



Frequency

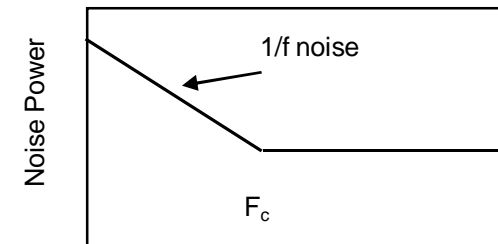

Frequency

# Johnson (thermal) Noise

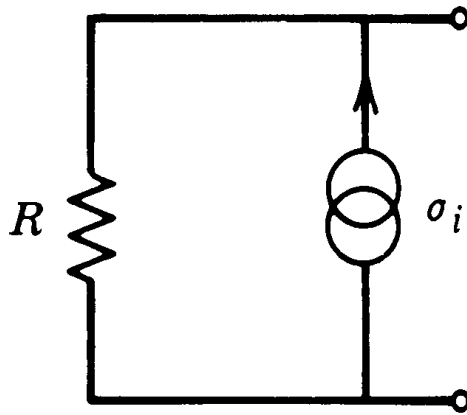

Noise in a resistor can be modeled as due to a noiseless resistor in parallel with a noise current source

The variance of the noise current source is given by:

$$s_{i_n}^2 = \langle i_n^2 \rangle \approx \frac{4k_B T B}{R}$$

Where  $k_B$  is Boltzman's constant

T is the Temperature in Kelvins

B is the bandwidth in Hz (not bits/sec)

# Photodetection noise

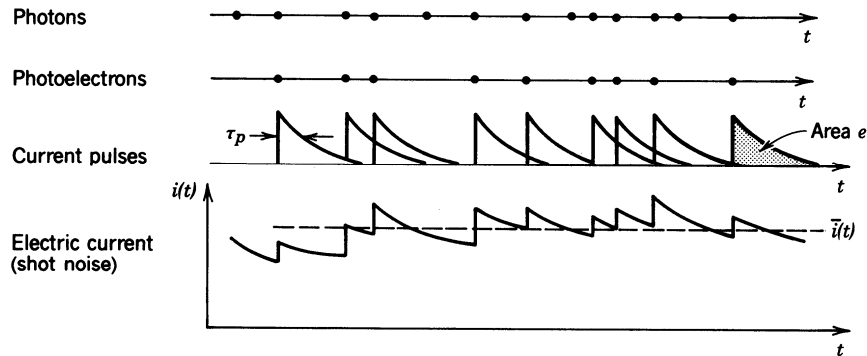

**Noise in photodetector**

The electric current in a photodetector circuit is composed of a superposition of the electrical pulses associated with each photoelectron

The variation of this current is called shot noise

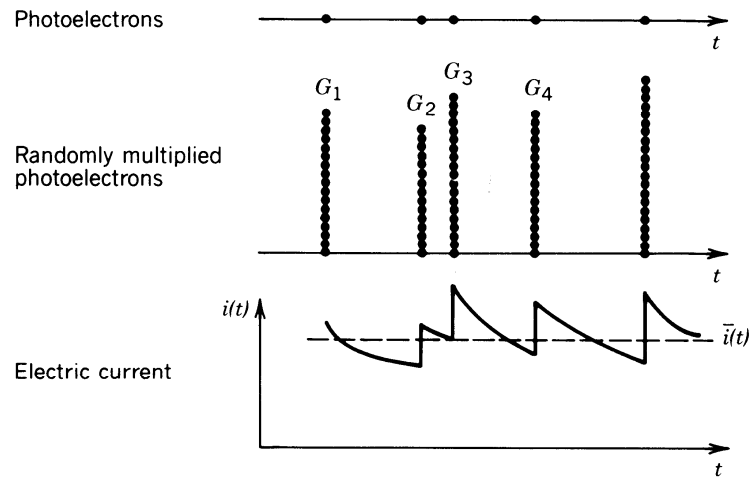

**Noise in APD**

If the photoelectrons are multiplied by a gain mechanism then variations in the gain mechanism give rise to an additional variation in the current pulses. This variation provides an additional source of noise, gain noise

# Circuit Noise

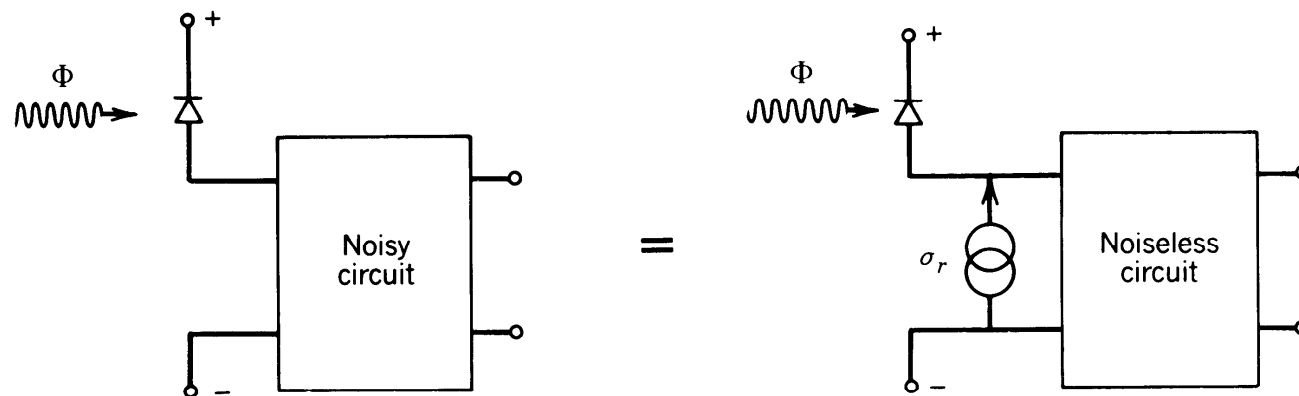

**Figure 17.5-6** Noise in the receiver circuit can be replaced with a single random current source with rms value  $\sigma_r$ .



# Signal to Noise Ratio

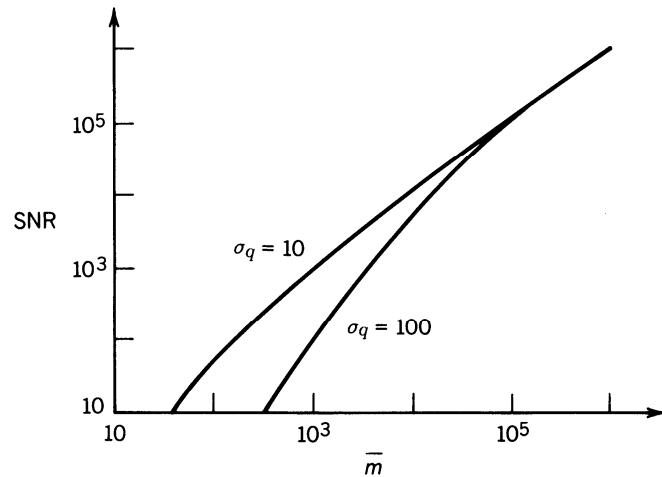

Signal to noise Ratio (SNR) as a function of the average number of photo electrons per receiver resolution time for a photo diode receiver at two different values of the circuit noise

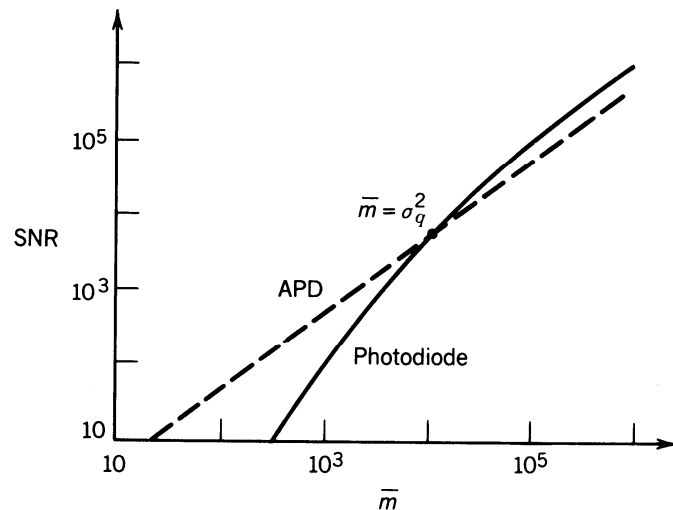

Signal to noise Ratio (SNR) as a function of the average number of photoelectrons per receiver resolution time for a photo diode receiver and an APD receiver with mean gain  $G=100$  and an excess noise factor  $F=2$

At low photon fluxes the APD receiver has a better SNR. At high fluxes the photodiode receiver has lower noise

## Dependence of SNR on APD Gain

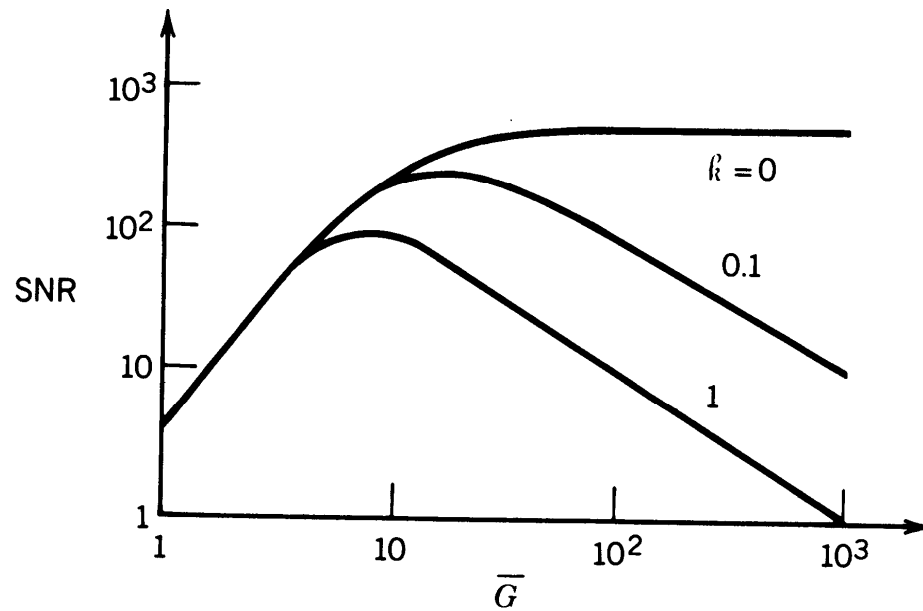

Curves are parameterized by  $k$ , the ionization ratio between holes and electrons

Plotted for an average detected photon flux of 1000 and constant circuit noise

# Digital Transmission System (DTS)

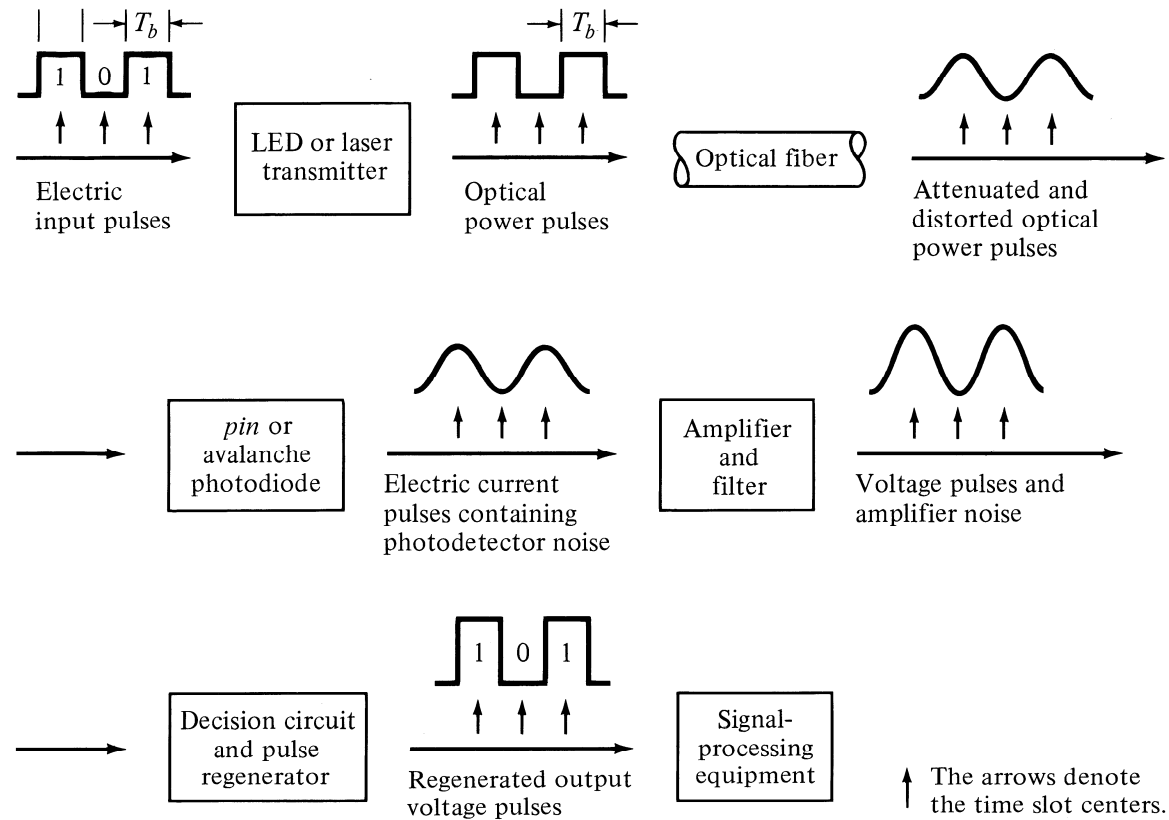

- The design of optical receiver is much more complicated than that of optical transmitter because the receiver must first detect weak, distorted signals and then make decisions on what type of data was sent.

# Error Sources in DTS

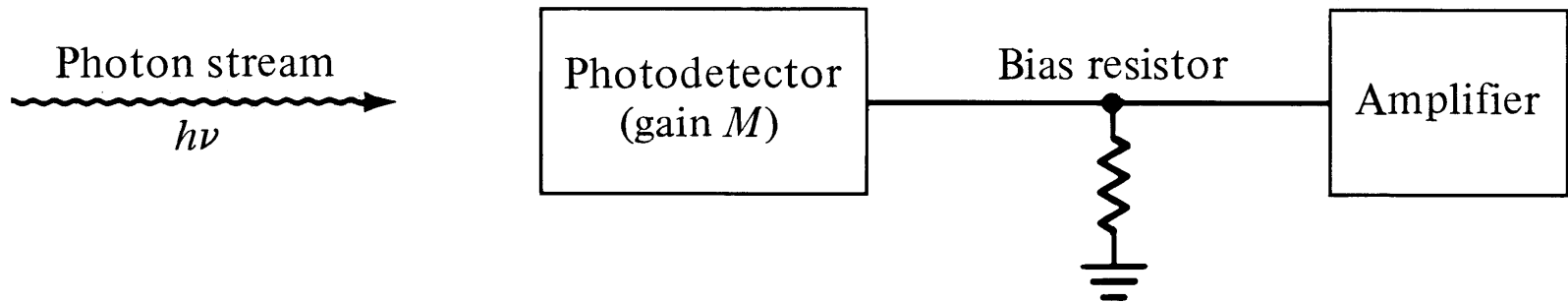

- Photon detection quantum noise (Poisson fluctuation)

$$\bar{N} = \frac{\eta}{h\nu} \int_0^{\tau} P(t) dt = \frac{\eta}{h\nu} E \quad [7-1]$$

$$P_r(n) = \bar{N}^n \frac{e^{-\bar{N}}}{n!} \quad [7-2]$$

- Bulk dark current
- Surface leakage current
- Statistical gain fluctuation (for avalanche photodiodes)

- Thermal noise

- Amplifier noise

$\bar{N}$  is the average number of electron-hole pairs in photodetector,  $\eta$  is the detector quantum efficiency and  $E$  is energy received in a time interval  $\tau$  and  $h\nu$  is photon energy, where  $P_r(n)$  is the probability that  $n$  electrons are emitted in an interval  $\tau$ .

# InterSymbol Interference (ISI)

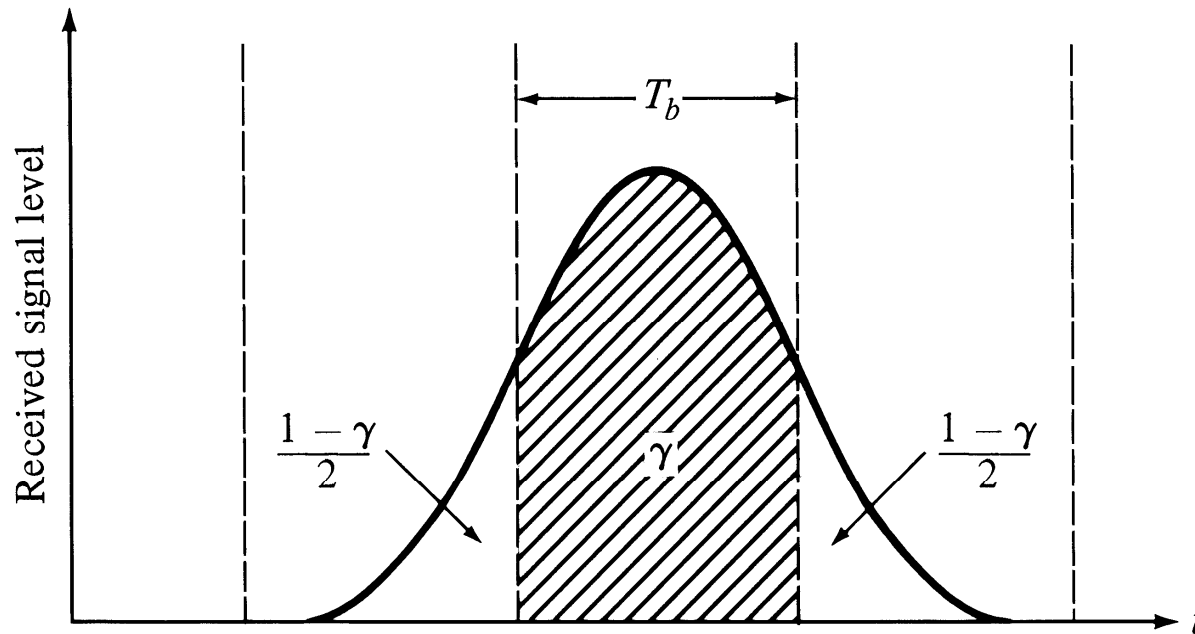

Pulse spreading in an optical signal, after traversing along optical fiber, leads to ISI. Some fraction of energy remaining in appropriate time slot is designated by  $\gamma$ , so the rest is the fraction of energy that has spread into adjacent time slots.

# Receiver Configuration

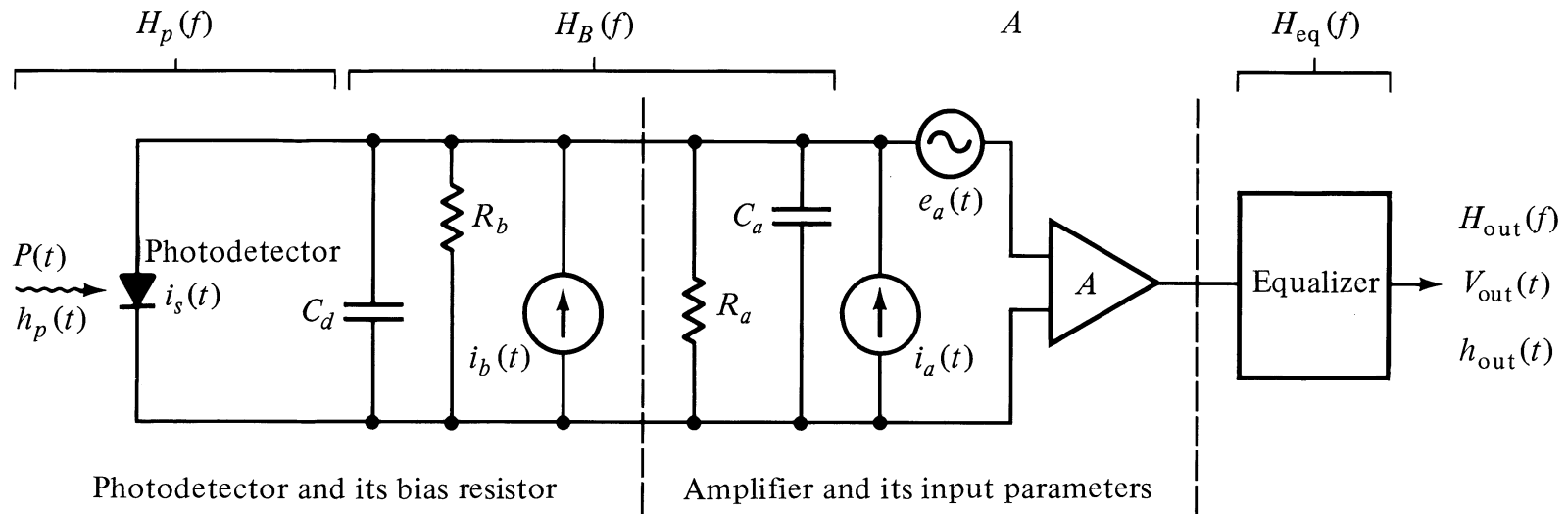

The binary digital pulse train incident on the photodetector can be written in the following form:

$$P(t) = \sum_{n=-\infty}^{+\infty} b_n h_p(t - nT_b) \quad [7-3]$$

where  $T_b$  is bit period,  $b_n$  is an amplitude parameter of the  $n$ th message digit and  $h_p(t)$  is the received pulse shape which is positive for all  $t$ .

- In writing down eq. [7-3], we assume the digital pulses with amplitude  $V$  represents bit 1 and 0 represents bit 0. Thus  $b_n$  can take two values corresponding to each binary data. By normalizing the input pulse  $h_p(t)$  to the photodiode to have unit area

$$\int_{-\infty}^{+\infty} h_p(t) dt = 1$$

$b_n$  represents the energy in the  $n$ th pulse.

The mean output current from the photodiode at time  $t$  resulting from pulse train given in eq. [7-3] is (neglecting the DC components arising from dark current noise):

$$\langle i(t) \rangle = \frac{\eta q}{h\nu} MP(t) = \mathfrak{R}_o M \sum_{n=-\infty}^{+\infty} b_n h_p(t - nT_b) \quad [7-4]$$

## Bit Error Rate (BER)

BER = Probability of Error =

$$\frac{\text{\# of error over a certain time interval } t}{\text{total \# of pulses transmitted during } t} = \quad [7-5]$$

$$\frac{N_e}{N_t} = \frac{N_e}{Bt} \quad B = 1/T_b$$

- **Probability of Error**= probability that the output voltage is less than the threshold when a 1 is sent + probability that the output voltage is more than the threshold when a 0 has been sent.



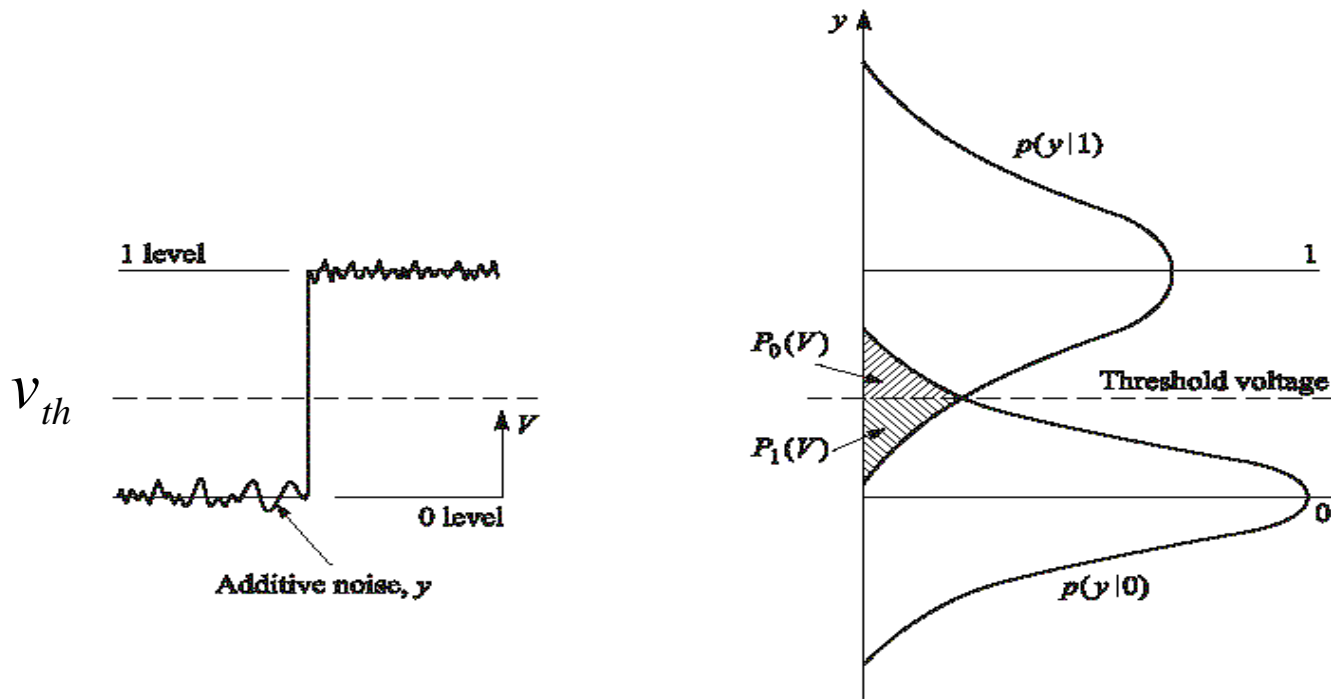

Probability distributions for received logical 0 and 1 signal pulses. the different widths of the two distributions are caused by various signal distortion effects.

$$P_1(v) = \int_{-\infty}^v p(y|1)dy \quad \text{probability that the equalizer output voltage is less than } v, \text{ if 1 transmitted} \quad [7-6]$$

$$P_0(v) = \int_v^{\infty} p(y|0)dy \quad \text{probability that the equalizer output voltage exceeds } v, \text{ if 0 transmitted}$$

$$P_e = q_1 P_1(v_{th}) + q_0 P_0(v_{th})$$

$$= q_1 \int_{-\infty}^{v_{th}} p(y | 1) dy + q_0 \int_{v_{th}}^{\infty} p(y | 1) dy$$

[7-7]

- Where  $q_1$  and  $q_0$  are the probabilities that the transmitter sends 0 and 1 respectively.

$$q_0 = 1 - q_1 \quad q_0 = q_1 = 0.5$$

- For an unbiased transmitter

# Gaussian Distribution

$$P_1(v_{th}) = \int_{-\infty}^{v_{th}} p(y | 1) dy = \frac{1}{\sqrt{2\pi}\sigma_{on}} = \int_{-\infty}^{v_{th}} \exp\left[-\frac{(v - b_{on})^2}{2\sigma_{on}^2}\right] dv \quad [7-8]$$

$$P_0(v_{th}) = \int_{v_{th}}^{\infty} p(y | 0) dy = \frac{1}{\sqrt{2\pi}\sigma_{off}} = \int_{v_{th}}^{\infty} \exp\left[-\frac{(v - b_{off})^2}{2\sigma_{off}^2}\right] dv$$

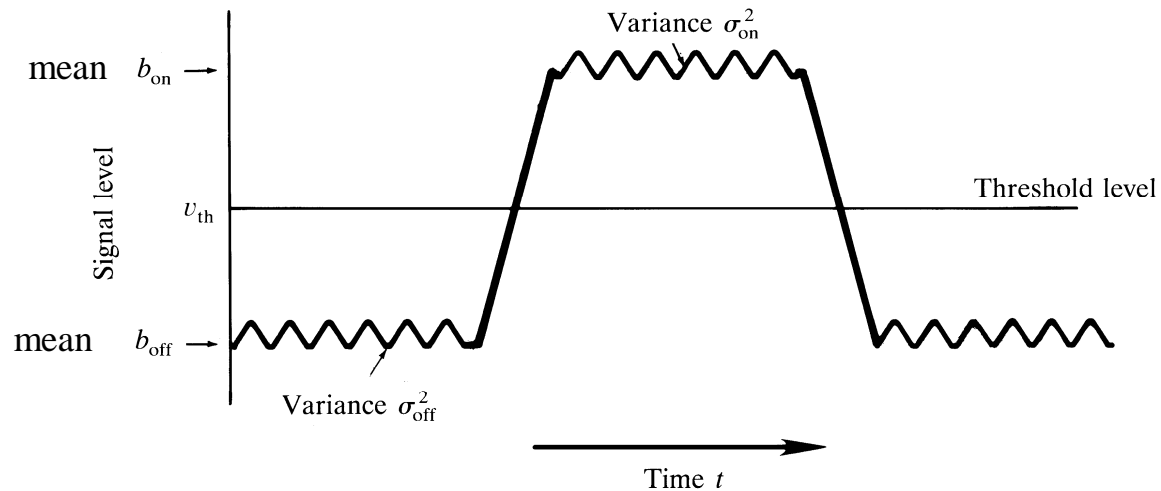

- If we assume that the probabilities of 0 and 1 pulses are equally likely, then using eq [7-7] and [7-8] , BER becomes:

$$\text{BER} = P_e(Q) = \frac{1}{\sqrt{\pi}} \int_{Q/\sqrt{2}}^{\infty} \exp(-x^2) dx = \frac{1}{2} \left[ 1 - \text{erf} \left( \frac{Q}{\sqrt{2}} \right) \right]$$

$$\approx \frac{1}{\sqrt{2\pi}} \frac{\exp(-Q^2/2)}{Q} \quad [7-9]$$

$$Q = \frac{v_{th} - b_{off}}{\sigma_{off}} = \frac{b_{on} - v_{th}}{\sigma_{on}} \quad [7-9]$$

$$\text{erf}(x) = \frac{2}{\sqrt{\pi}} \int_0^x \exp(-y^2) dy \quad [7-10]$$

Variation of BER vs  $Q$ ,  
according to eq [7-9].

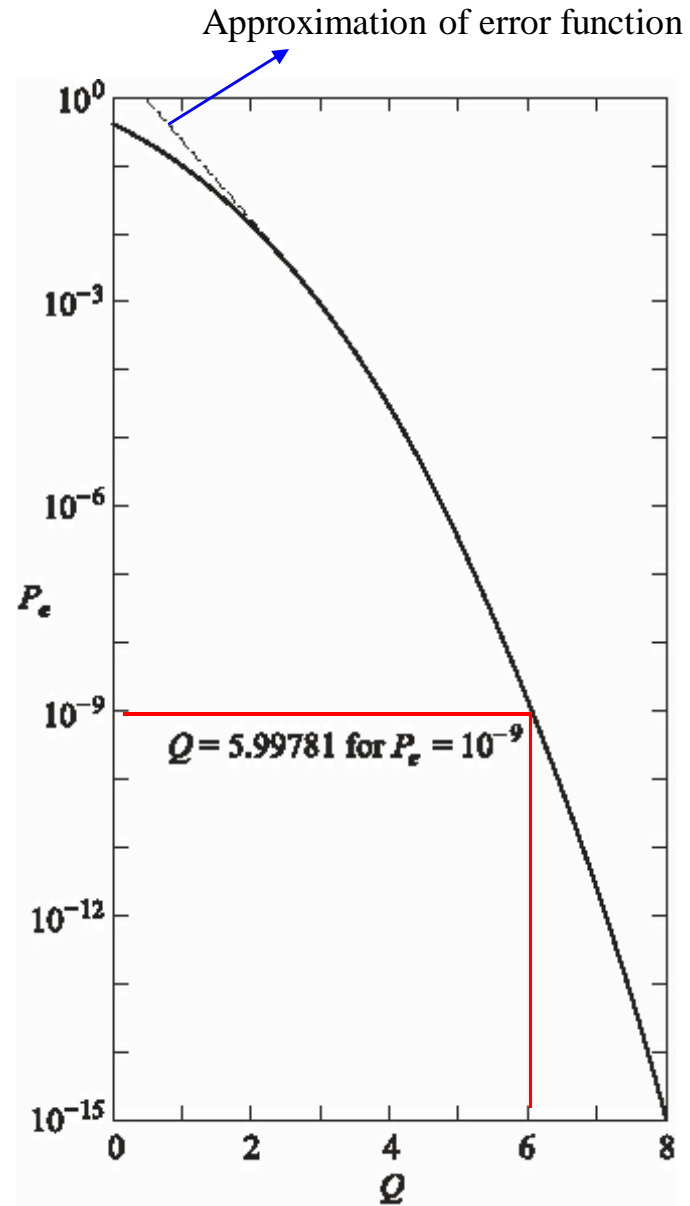

# Special Case

In special case when:

$$\sigma_{\text{off}} = \sigma_{\text{on}} = \sigma \ \& \ b_{\text{off}} = 0, b_{\text{on}} = V$$

From eq [7-29], we have:  $v_{th} = V / 2$

Eq [7-8] becomes:

$$P_e(\sigma) = \frac{1}{2} \left[ 1 - \operatorname{erf} \left( \frac{V}{2\sqrt{2}\sigma} \right) \right] \quad [7-11]$$

$\frac{V}{\sigma}$  is peak signal - to - rms - noise ratio.

Study example 7-1 pp. 286 of the textbook.

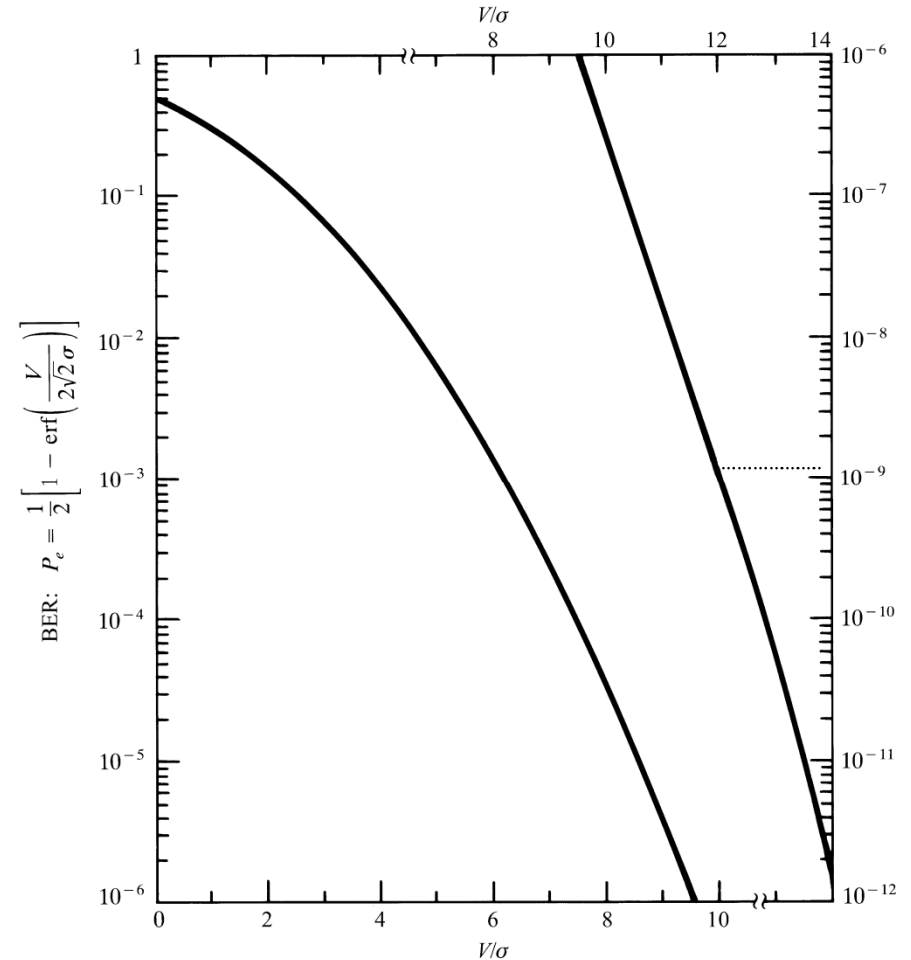

## Quantum Limit

- Minimum received power required for a specific BER assuming that the photodetector has a 100% quantum efficiency and zero dark current. For such ideal photo-receiver,

$$P_e = P_1(0) = \exp(-\bar{N}) \quad [7-12]$$

- Where  $\bar{N}$  is the average number of electron-hole pairs, when the incident optical pulse energy is E and given by eq [7-1] with 100% quantum efficiency .

$$(\eta = 1)$$

## **Unit -V**

# **DIGITAL TRANSMISSION SYSTEM**

- Point-to-Point links – System considerations – Fiber Splicing and connectors – Link Power budget – Rise-time budget – Noise Effects on System Performance – Operational Principals of WDM, Solutions



# Point-to-Point Links

Key system requirements needed to analyze optical fiber links:

1. The desired (or possible) transmission distance
2. The data rate or channel bandwidth
3. The desired bit-error rate (BER)

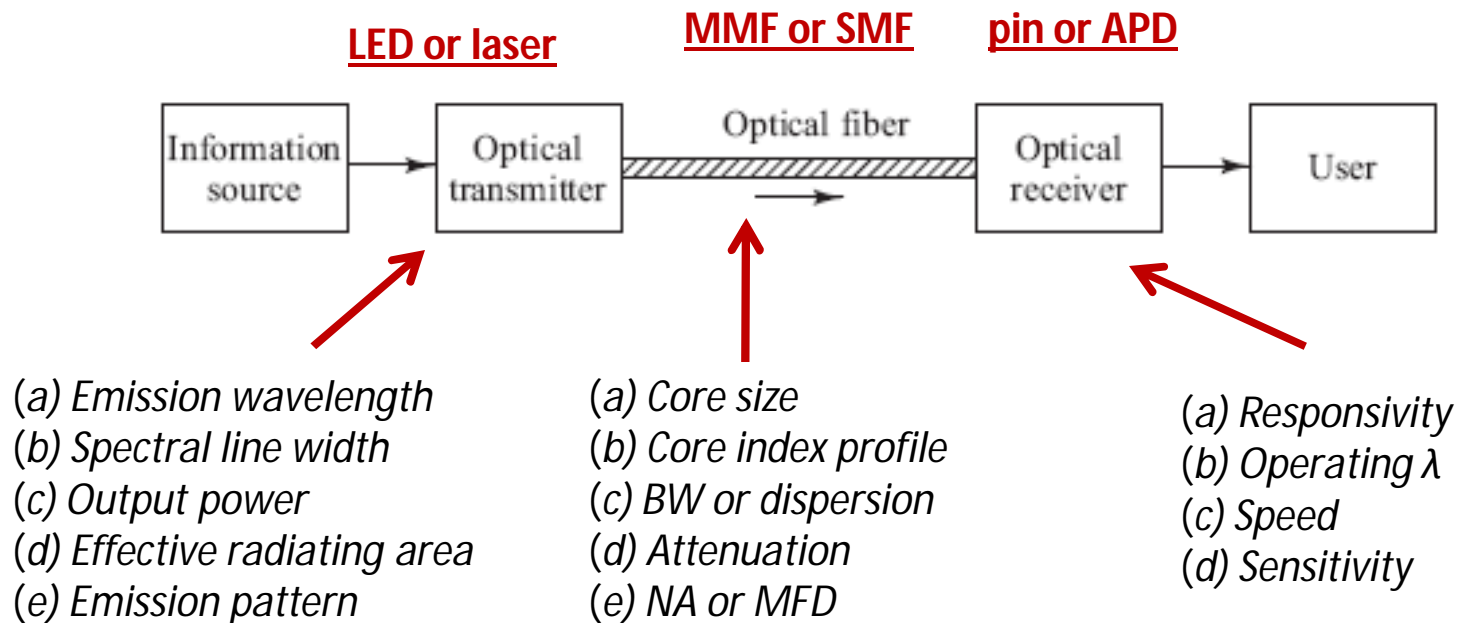

## Selecting the Fiber

Bit rate and distance are the major factors

Other factors to consider: attenuation (depends on?)  
and distance-bandwidth product (depends on?) cost  
of the connectors, splicing etc.

Then decide

- Multimode or single mode
- Step or graded index fiber

## Selecting the Optical Source

- Emission wavelength depends on acceptable attenuation and dispersion
- Spectral line width depends on acceptable ..... dispersion (LED → wide, LASER → narrow)
- Output power in to the fiber (LED → low, LASER → high)
- Stability, reliability and cost
- Driving circuit considerations

## Selecting the detector

- Type of detector
  - APD: High sensitivity but complex, high bias voltage (40V or more) and expensive
  - PIN: Simpler, thermally stable, low bias voltage (5V or less) and less expensive
- Responsivity (that depends on the avalanche gain & quantum efficiency)
- Operating wavelength and spectral selectivity
- Speed (capacitance) and photosensitive area
- Sensitivity (depends on noise and gain)

## Typical bit rates at different wavelengths

Wavelength	<b>LED</b> Systems	<b>LASER</b> Systems.
800-900 nm (Typically Multimode Fiber)	150 Mb/s.km	2500 Mb/s.km
1300 nm (Lowest dispersion)	1500 Mb/s.km	25 Gb/s.km (InGaAsP Laser)
1550 nm (Lowest Attenuation)	1200 Mb/s.km	Up to 500 Gb/s.km (Best demo)

## **Fusion Splicing Method**

Fusion splicing is a permanent connection of two or more optical fibers by welding them together using an electronic arc. It is the most widely used method of splicing as it provides for the lowest loss, less reflectance, strongest and most reliable joint between two fibers. When adopting this method, [fusion splicing machines](#) are often used. Generally, there are four basic steps in fusion splicing process as illustrating in following one by one.

## **Step 1: strip the fiber**

The splicing process begins with the preparation for both fibers ends to be fused. So you need to strip all protective coating, jackets, tubes, strength members and so on, just leaving the bare fiber showing. It is noted that the cables should be clean.

## **Step 2: cleave the fiber**

A good fiber cleaver is crucial to a successful fusion splice. The cleaver merely nicks the fiber and then pulls or flexes it to cause a clean break rather than cut the fiber. The cleave end-face should be perfectly flat and perpendicular to the axis of the fiber for a proper splice.

### **Step 3: fuse the fiber**

When fusing the fiber, there are two important steps: aligning and melting. First of all, aligning the ends of the fiber within the fiber optic splicer. Once proper alignment is achieved, utilizing an electrical arc to melt the fibers to permanently welding the two fiber ends together.

### **Step 4: protect the fiber**

A typical fusion splice has a tensile strength between 0.5 and 1.5 lbs and it is not easy to break during normal handling. However, it still requires protection from excessive bending and pulling forces. By using heat shrink tubing, silicone gel and/or mechanical crimp protectors will keep the splice protected from outside elements and breakage.



## **Mechanical Splicing Method**

A mechanical splice is a junction of two or more optical fibers that are aligned and held in place by a self-contained assembly. A typical example of this method is the use of connectors to link fibers. This method is most popular for fast, temporary restoration or for splicing multimode fibers in a premises installation. Like fusion splice, there are also four basic steps in mechanical splice.

## **Step 1: strip the fiber**

Fiber preparation here is practically the same as for fusion splicing. Just removing the protective coatings, jackets, tubes, strength members to show the bare fiber. Then ensuring the cleanliness of the fiber.

## **Step 2: cleave the fiber**

The process is the same as the cleaving for fusion splicing. It is necessary to obtain a cut on the fiber which is exactly at right angles to the axis of the fiber.

### **Step 3: mechanically join the fiber**

In this step, heating is not used as in fusion splice. Simply connecting the fiber ends together inside the mechanical splice unit. The index matching gel inside the mechanical splice apparatus will help couple the light from one fiber end to the other.

### **Step 4: protect the fiber**

Once fibers are spliced, they will be placed in a splice tray which is then placed in a splice closure. Outside plant closures without use of heat shrink tubing will be carefully sealed to prevent moisture damage to the splices.

# **Wavelength Division Multiplexing (WDM)**

## **Why Is WDM Used?**

With the exponential growth in communications, caused mainly by the wide acceptance of the Internet, many carriers are finding that their estimates of fiber needs have been highly underestimated. Although most cables included many spare fibers when installed, this growth has used many of them and new capacity is needed. Three methods exist for expanding capacity: 1) installing more cables, 2) increasing system bitrate to multiplex more signals or 3) wavelength division multiplexing.

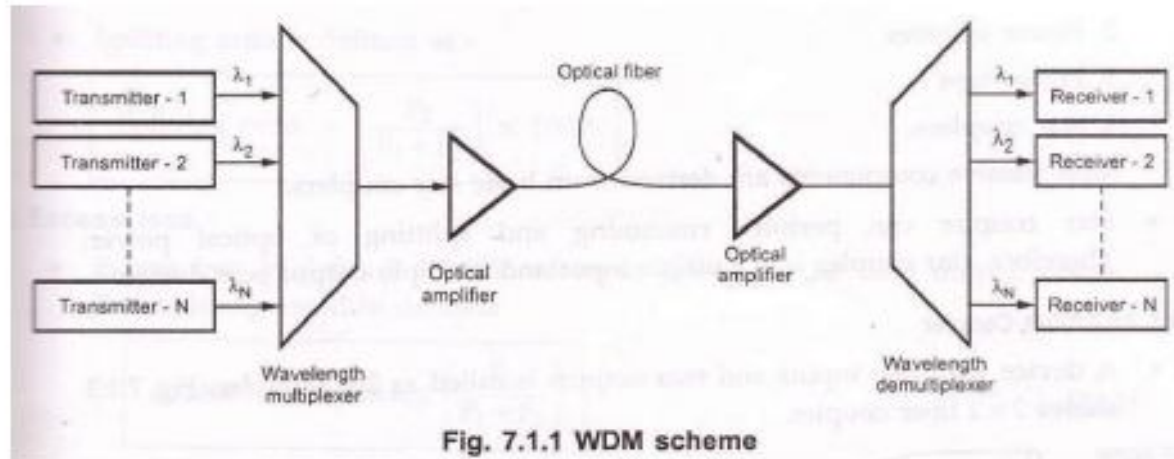

- To prevent spurious signals to enter into receiving channel, the demultiplexer must have narrow spectral operation with sharp wavelength cut-offs. The acceptable limit of crosstalk is  $-30$  dB.

### Features of WDM

- Important advantages or features of WDM are as mentioned below –
  1. Capacity upgrade : Since each wavelength supports independent data rate in Gbps.
  2. Transparency : WDM can carry fast asynchronous, slow synchronous, synchronous analog and digital data.
  3. Wavelength routing : Link capacity and flexibility can be increased by using multiple wavelength.
  4. Wavelength switching : WDM can add or drop multiplexers, cross connects and wavelength converters.

## Design Considerations

- Link Power Budget
  - There is enough power margin in the system to meet the given BER
- Rise Time Budget
  - Each element of the link is fast enough to meet the given bit rate

These two budgets give necessary conditions  
for satisfactory operation

# Optical power-loss model

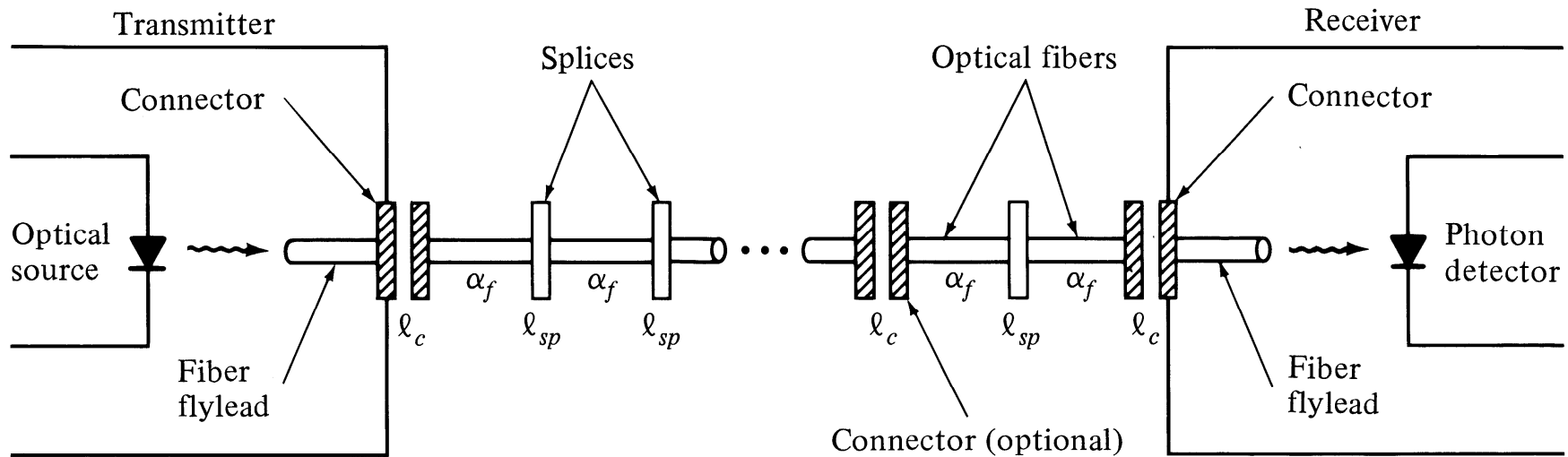

$$P_T = P_s - P_R = m\lambda_c + n\lambda_{sp} + \alpha_f L + \text{System Margin}$$

$P_T$ : Total loss;  $P_s$ : Source power;  $P_R$ : Rx sensitivity

$m$  connectors;  $n$  splices

# Power Budget Example

- Specify a 20-Mb/s data rate and a BER =  $10^{-9}$ .
- With a Si *pin* photodiode at 850 nm, the required receiver input signal is -42 dBm.
- Select a GaAlAs LED that couples 50 mW into a 50- $\mu$ m core diameter fiber flylead.
- Assume a 1-dB loss occurs at each cable interface and a 6-dB system margin.
- The possible transmission distance  $L = 6$  km can be found from

$$P_T = P_S - P_R = 29 \text{ dB} = 2l_c + \alpha L + \text{system margin} = 2(1 \text{ dB}) + \alpha L + 6 \text{ dB}$$

- The link power budget can be represented graphically (see the right-hand figure).

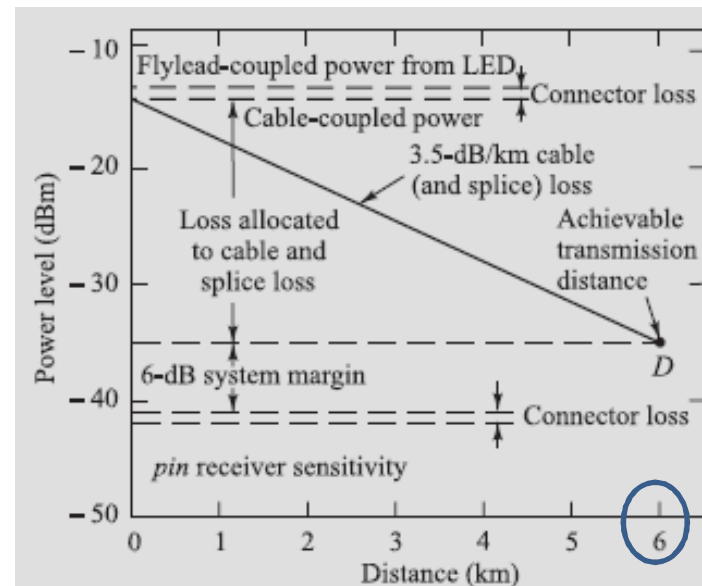
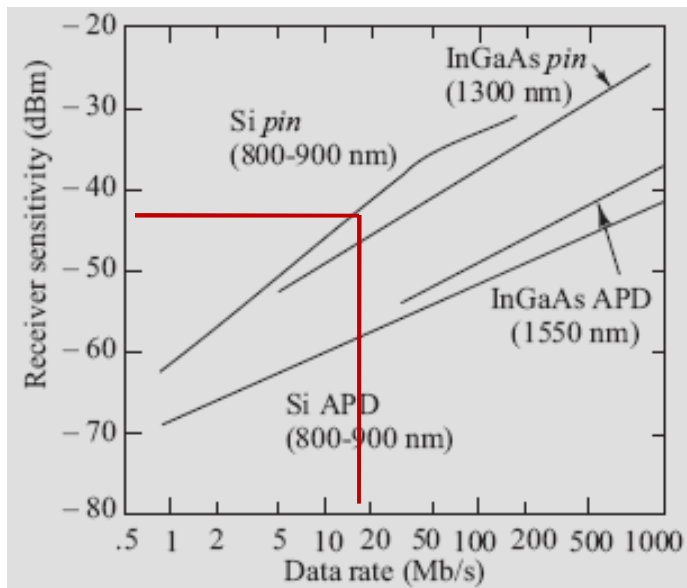



## Rise-Time Budget (1)

- A *rise-time budget analysis* determines the dispersion limitation of an optical fiber link.
- The total rise time  $t_{sys}$  is the root sum square of the rise times from each contributor  $t_i$  to the pulse rise-time degradation:
  - The transmitter rise time  $t_{tx}$
  - The group-velocity dispersion (GVD) rise time  $t_{GVD}$  of the fiber

The modal dispersion rise time  $t_{\text{mod}}$  of the fiber

The receiver rise time  $t_{\text{rx}}$

$$t_{\text{sys}} = \left[ t_{\text{rx}}^2 + t_{\text{mod}}^2 + t_{\text{GVD}}^2 + t_{\text{rx}}^2 \right]^{1/2}$$
$$= \left[ t_{\text{rx}}^2 + \left( \frac{440L^q}{B_0} \right)^2 + D^2 \sigma_\lambda^2 L^2 + \left( \frac{350}{B_e} \right)^2 \right]^{1/2}$$

Here  $B_e$  and  $B_0$  are given in MHz, so all times are in ns.

## Solitons

- Soliton is very narrow, high intensity optical pulses.
- Retain their shape through the interaction of balancing pulse dispersion with non linear properties of an optical fiber.
- ▶ GVD causes most pulses to broaden in time, but soliton takes advantage of non-linear effects in silica (SPM) resulting from Kerr nonlinearity, to over come the pulse broadening effects of GVD

- Depending on the particular shape chosen, the pulse either does not change its shape as it propagate, or it undergoes periodically repeating change in shape.
- The family of pulse that do not change in shape are called **Fundamental Soliton**.
- The family of pulse that undergo periodic shape change are called **Higher order soliton**.

# In OFC, Solitons

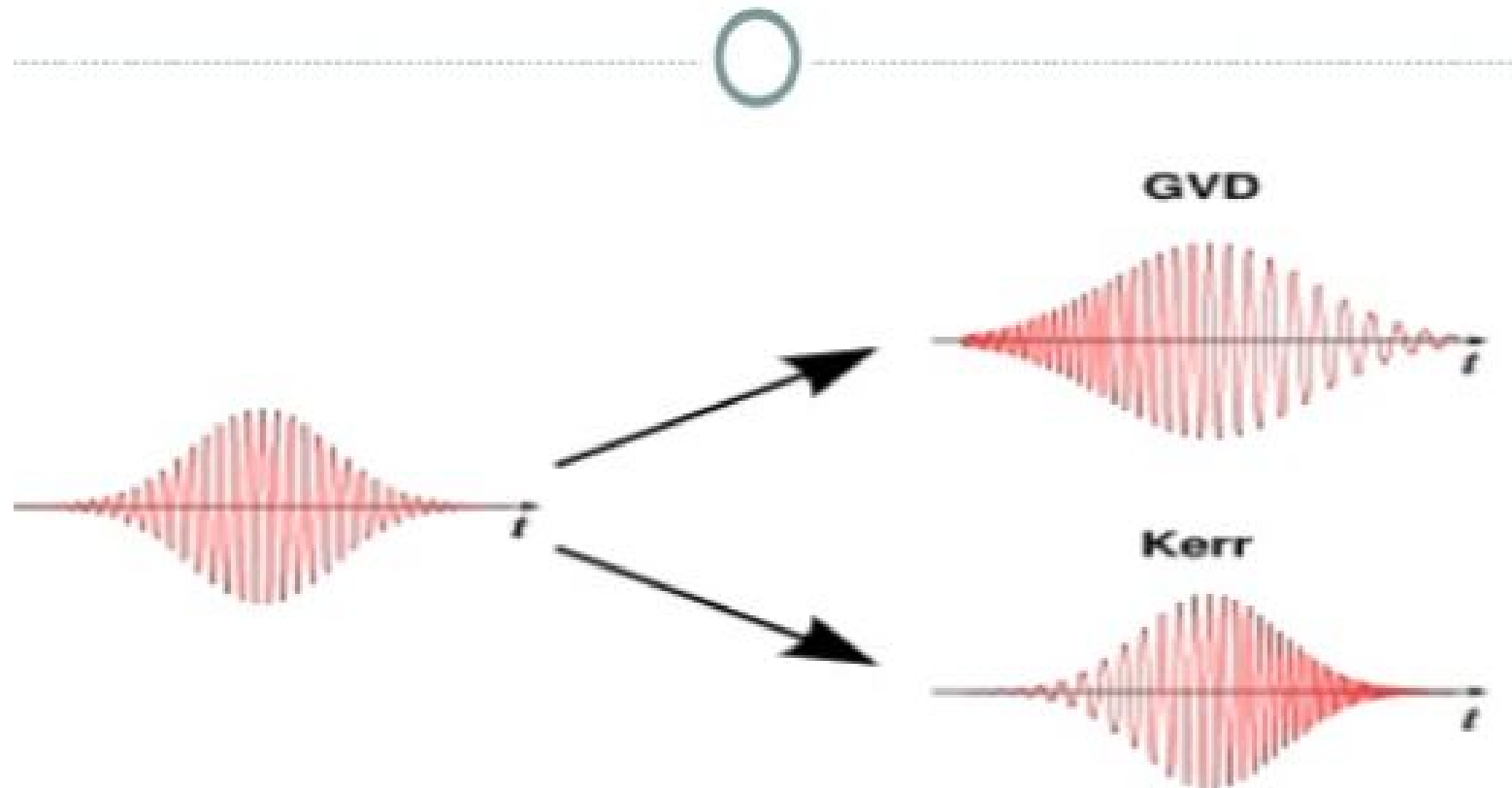

On the left there is a standard Gaussian pulse, that's the envelope of the field oscillating at a defined frequency. ***frequency remains perfectly constant*** during the pulse.

# Soliton Pulses



## 1. Medium with Positive GVD

Leading part of the pulse is shifted toward lower frequencies, so the speed in that portion increases.

In trailing half, the frequency rises so the speed decreases. This causes trailing edge to be further delayed.

Also energy in the centre of pulse is dispersed to either side, and pulse takes on a rectangular wave shape.

These effects will severely limit high speed long distance transmission if the system is operated in this condition

# Soliton Pulses

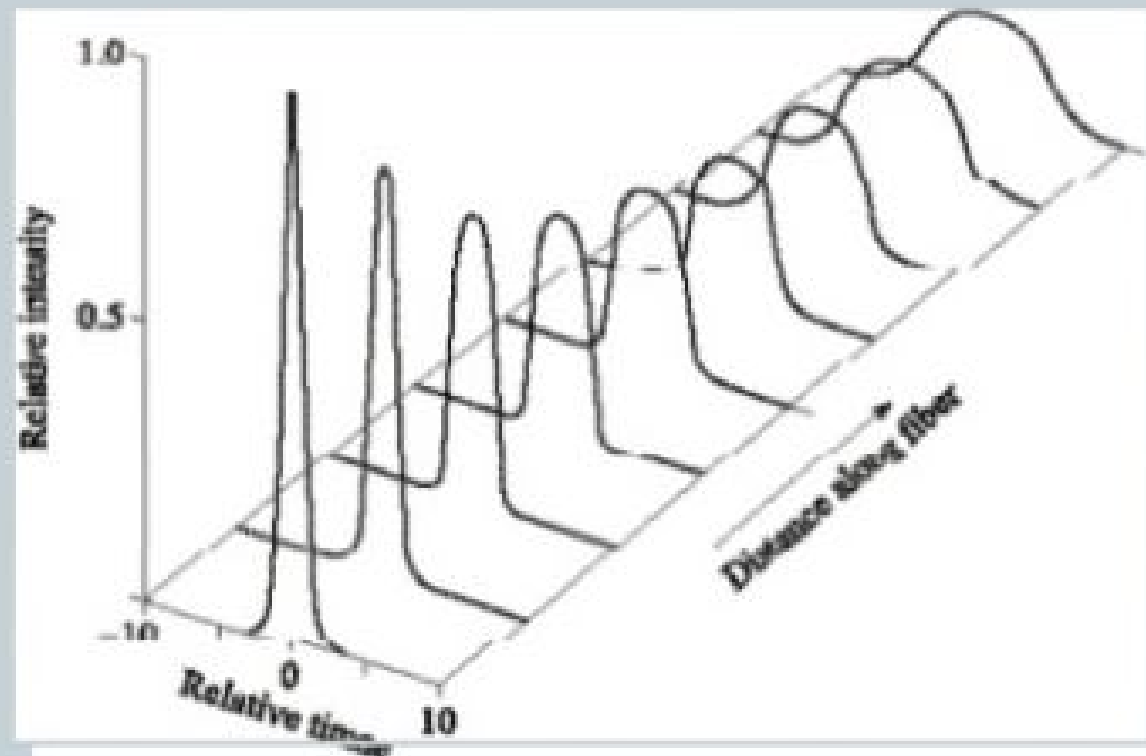

# Soliton Pulses

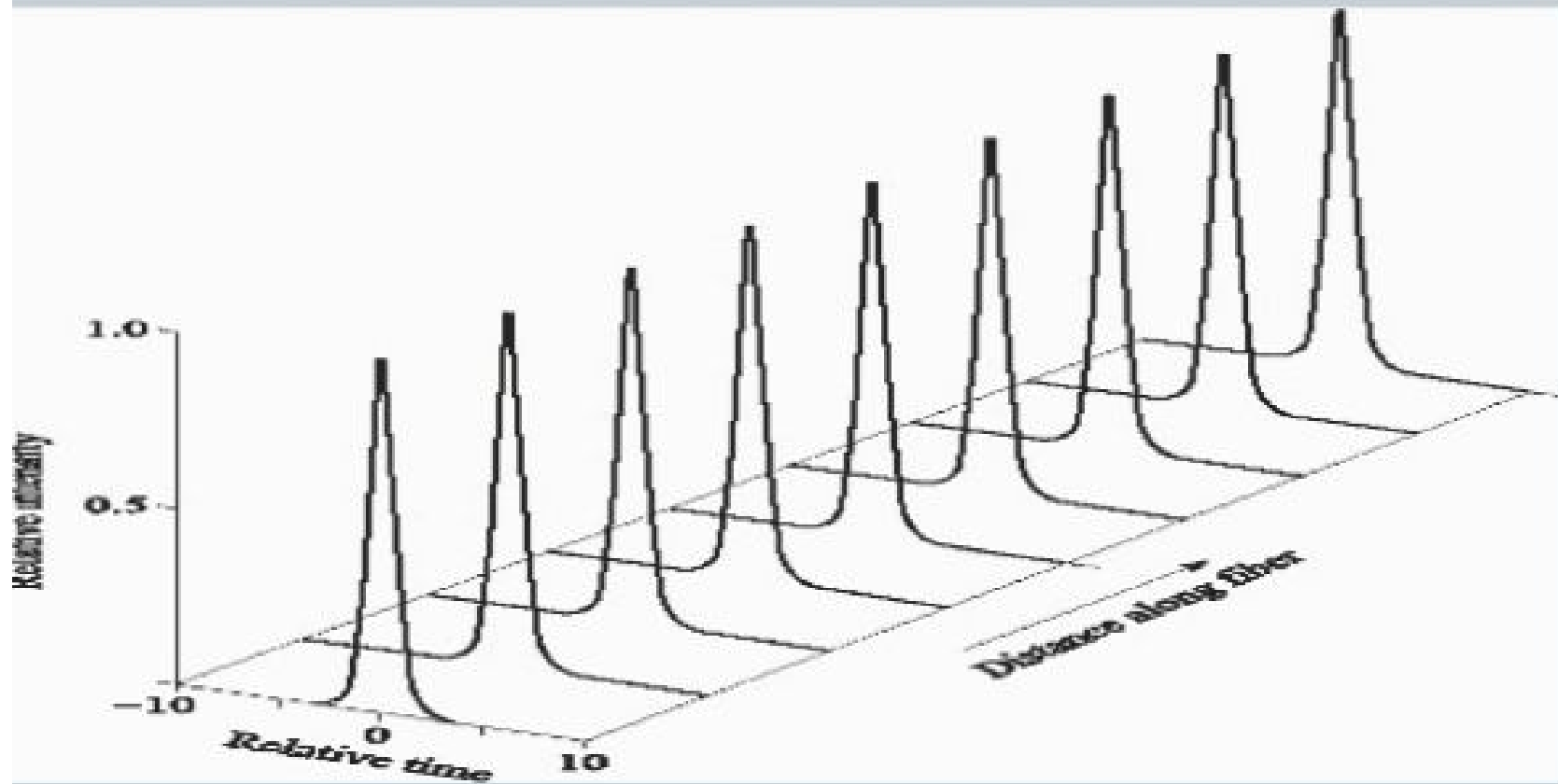



# Soliton Pulses

